



Assembly and Operating Instructions for Outback® Orion Charcoal BBQ



Photographs are not to scale.
Specifications subject to change
without prior notice.

TRC100



WARNING

- For outdoor use only - do not use indoors! Not for commercial use.
- Read instructions before using the appliance. Failure to follow instructions could result in death, serious bodily injury, and/or property loss.
- **WARNING!** Accessible parts may be very hot. Keep children and pets away!
- **WARNING!** Do not use spirit or petrol for lighting or re-lighting! Use only firelighters complying to EN1860-3!
- **WARNING!** This barbecue becomes very hot. Do not move it during operation!
- Install this barbecue on a safe and even surface.
- Any modification of the appliance, misuse, or failure to follow the instructions may be dangerous and will invalidate your warranty. This does not affect your statutory rights.
- Retain these instructions for future reference.
- Do not use the barbecue in a confined and/or habitable space e.g. houses, tents, caravans, motor homes, boats. Danger of carbon monoxide poisoning fatality.
- Do not cook before the fuel has a coating of ash.



Parts List

Quantity varies according to model purchased. Specifications subject to change without prior notice. For more details on hardware, please see the corresponding 'Hardware Reference Diagram'.

	CODE	PART	QTY	OUTBACK® ORION CHARCOAL BBQ
Hood	A1	Hood	1	✓
	A2	Outback® Logo Badge	1	✓+
	A3	Heat Indicator	1	✓+
	A4	Hood Handle	1	✓
	A5	Hood / Ash Pan Handle Base	2	✓
	A6	Upper Hinge	2	✓
	A7	Warming Rack	1	✓
Body	B1	Fix Box Front Panel with Charcoal Door	1	✓
	B2	Fix Box Back Panel	1	✓
	B3	Fix Box Left Panel	1	✓
	B4	Fix Box Right Panel	1	✓
	B5	Lower Hinge	2	✓
	B6	Adjustable Charcoal Pan	1	✓+
	B7	Cooking Grid	2	✓
	B8	Air Vent	2	✓
	B9	Ash Pan	1	✓
	B10	Ash Pan Handle	1	✓
	B11	Charcoal Door Handle	1	✓
	B12	Charcoal Door Handle Base	1	✓
	B13	Charcoal Door Locking Lever	1	✓
	B14	Charcoal Pan Handle	1	✓
Trolley	C1	Left Back Leg	1	✓
	C2	Left Front Leg	1	✓
	C3	Right Back Leg	1	✓
	C4	Right Front Leg	1	✓
	C5	Leg End Cap	2	✓
	C6	Bottom Shelf	1	✓
	C7	Cart Handle	1	✓
	C8	Cart Handle Base	2	✓
	C9	Bottle Opener	1	✓
	C10	Right Side Table with Hooks	1	✓
	C11	Wheel Axle	1	✓
	C12	Wheel	2	✓
	C13	Wheel Hubcap	2	✓

✚ Pre-Assembled Component





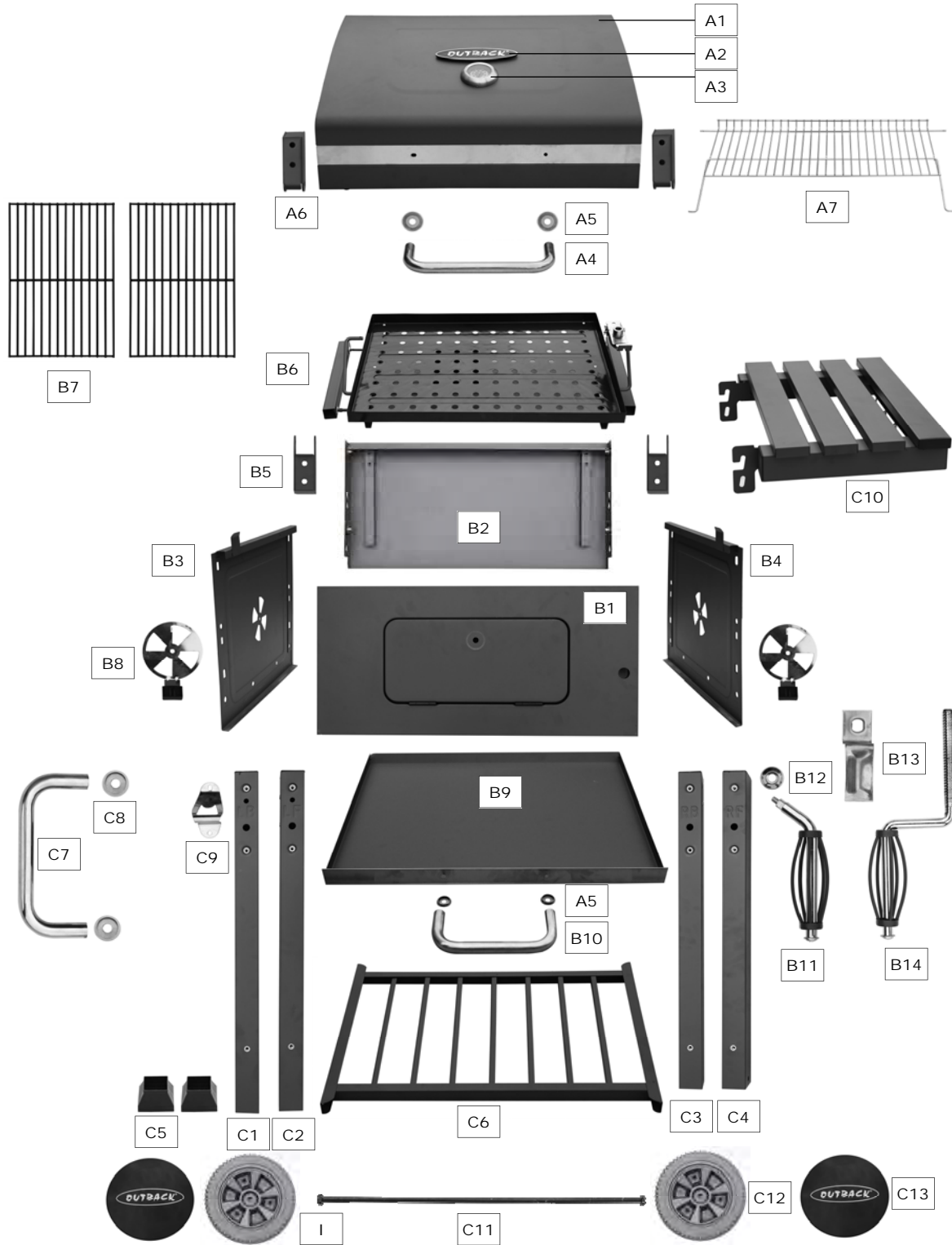





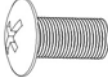

Parts Diagram

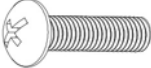
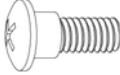
Quantity varies according to model purchased. Specifications subject to change without prior notice. For more details on hardware, please see the corresponding 'Hardware Reference Diagram'.



Hardware Reference Diagram

Specifications subject to change without prior notice.

CODE	PART	PICTURE	QTY
A	M6x10 Bolt		29
B	M6x35 Bolt		4
C	M6x45 Bolt		4
D	M6x70 Bolt		2
E	M5x16 Bolt		4
F	M5x28 Bolt		2
G	M6 Half Screw Thread Bolt		4
H	M6 Nut		9
I	M10 Nut		2
J	Hinge Pin		2
K	Cotter Pin		3
L	D6 Washer		13
M	D6 Spring Washer		13
N	M5x28 Half Screw Thread Bolt		1

Assembly

IMPORTANT!

- **TOOLS NEEDED FOR ASSEMBLY:** Medium size flat blade or Phillips/Crosspoint screwdriver, adjustable spanner or metric spanner set.
- Remove any internal components or packaging from the barbecue body.
- Whilst every care is taken in the manufacture of this product, care must be taken during assembly in case sharp edges are present.
- **Please read the Important Information section carefully before assembly and use of your barbecue.**

1

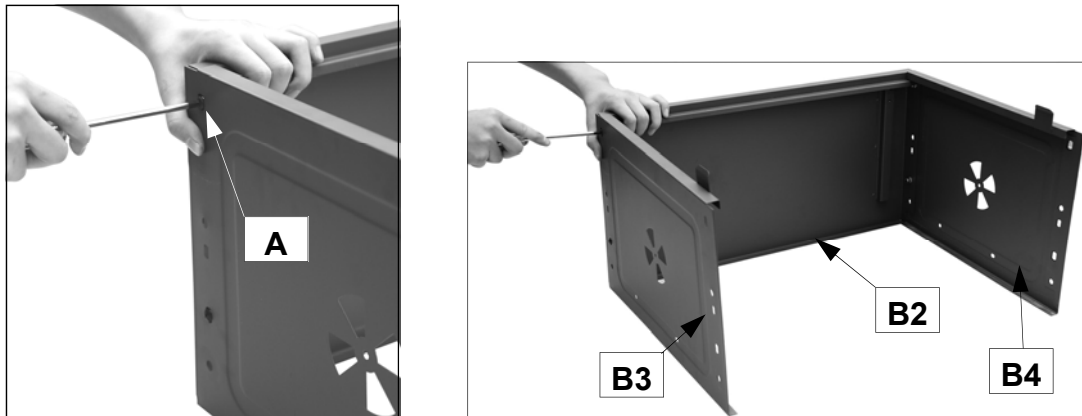

Fit the Fix Box Left Panel(B3), Fix Box Right Panel(B4) and the Fix Box Back Panel (B2) together using the M6x10 Bolts (Ax4pcs) as shown.

2

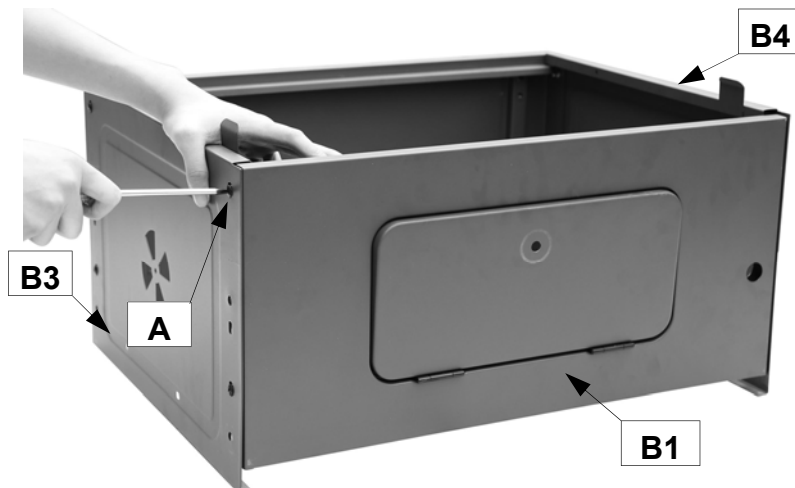

Attach the Fix Box Front Panel with Charcoal Door (B1) to the Fix Box Left Panel(B3) and Fix Box Right Panel(B4) using M6x10 Bolts (Ax4pcs) as shown.

3

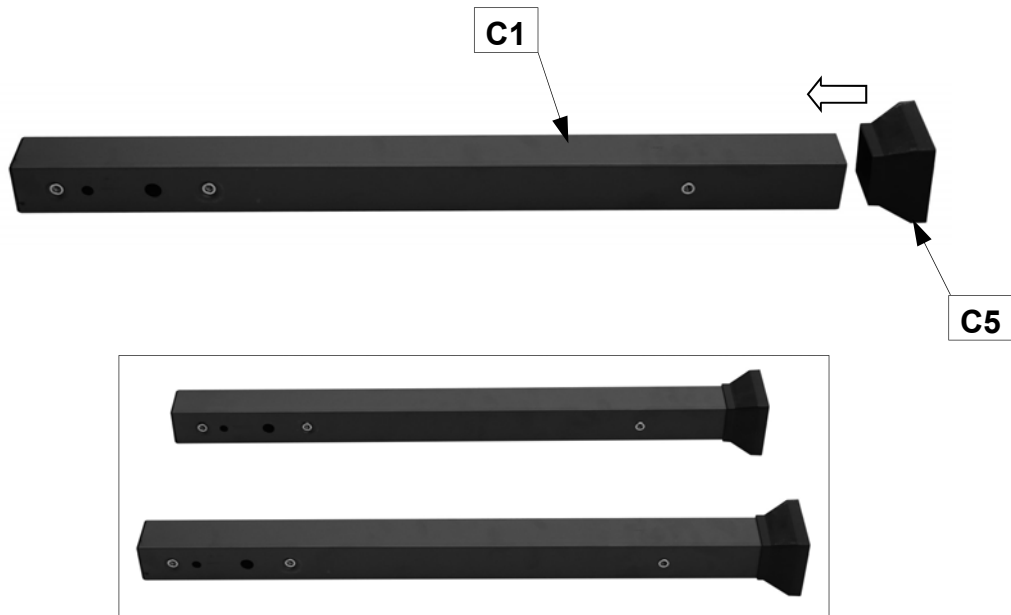

Attach the Leg End Cap(C5) to the Left Back Leg (C1) and Left Front Leg (C2) as shown.

4

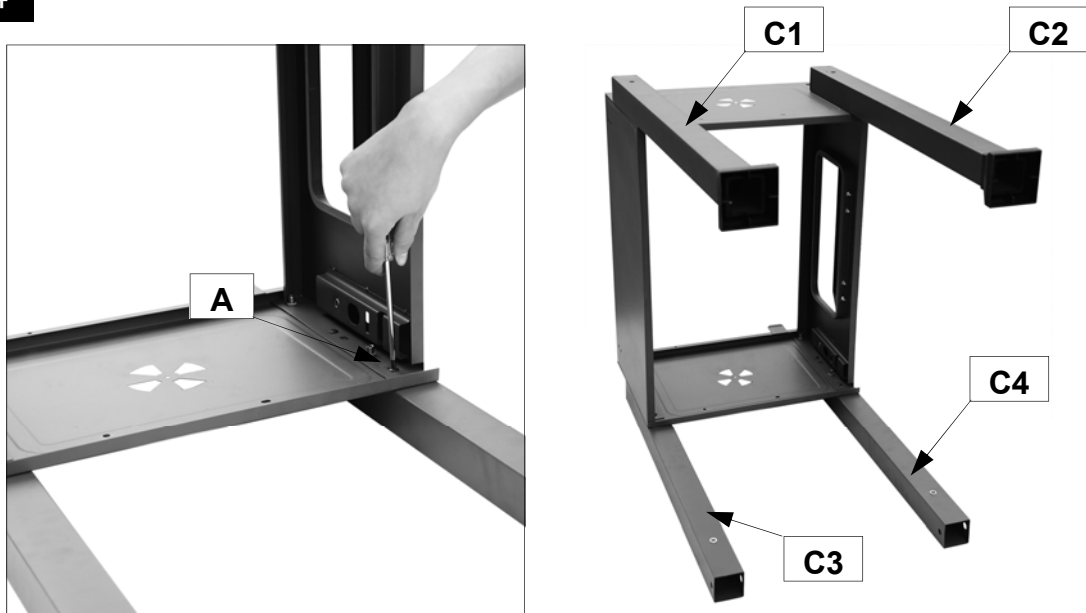

Attach the Legs (C1,C2,C3,C4) to the Fix Box Assembly using M6x10 Bolts (Ax8pcs) as shown.

5

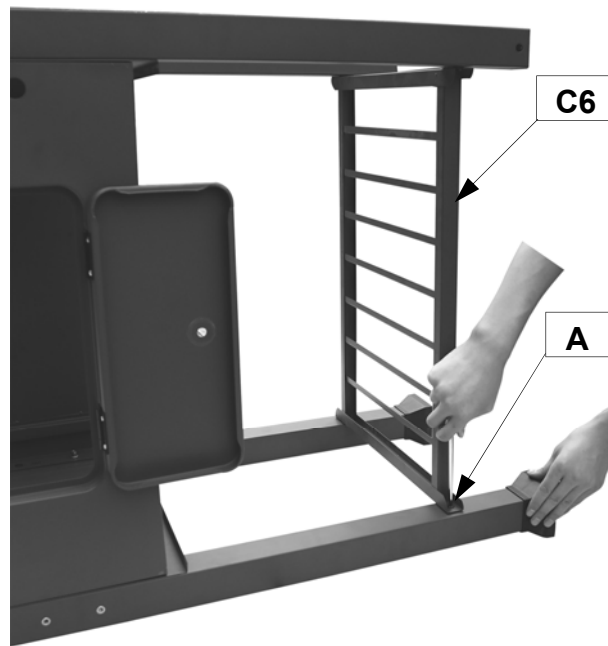

Attach the Bottom Shelf (C6) to the Legs using M6x10 Bolts (Ax4pcs) as shown.

6

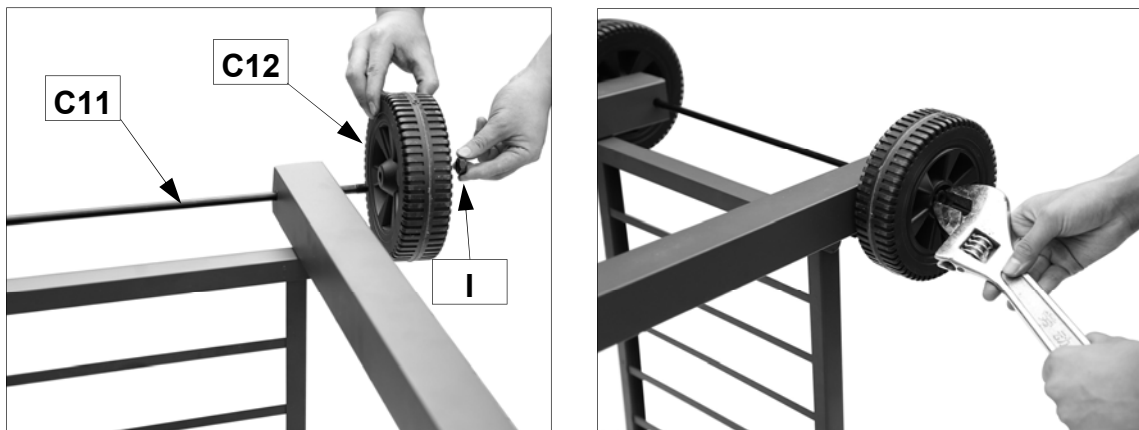

Slide the Wheel Axle (C11) through the corresponding holes in the right legs. Slide the Wheels (C12x2pcs) over each end of the axle. Secure the wheels into place with the M10 Nut (1x2pcs).

7

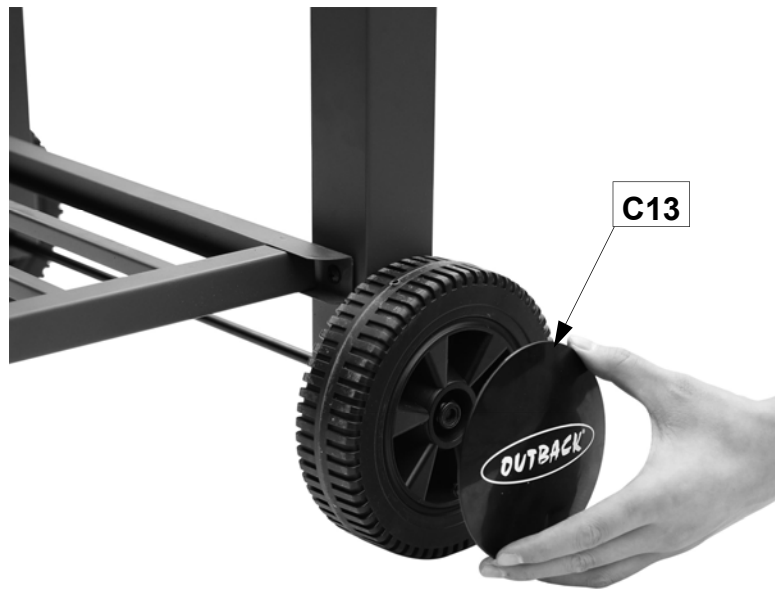

Place the Wheel Hubcap (C13x2pcs) onto the outsides of the wheels.

8

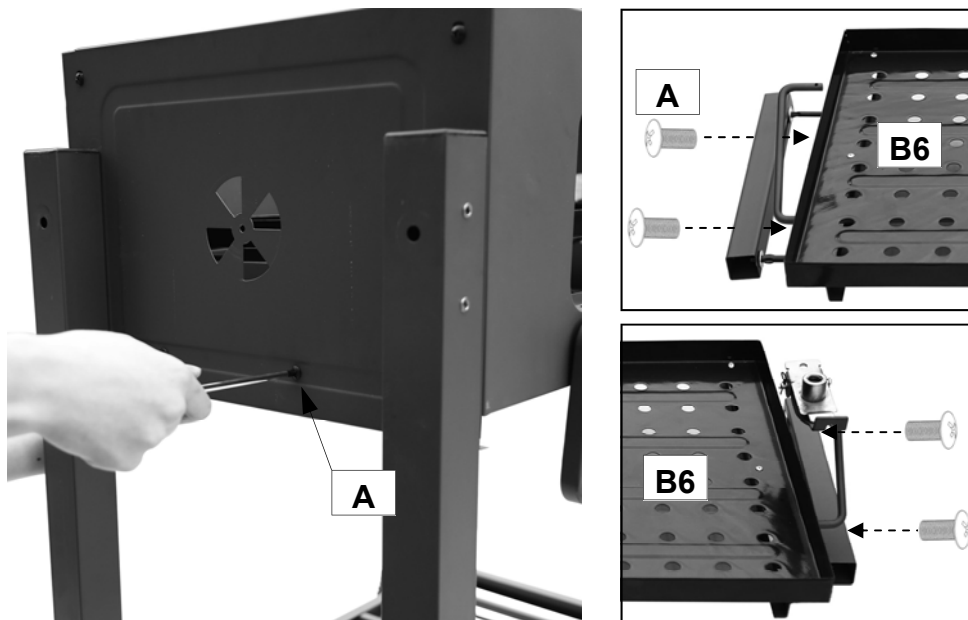

Fix the support of Adjustable Charcoal Pan to the Fix Box Left Panel and Right Panel (B3,B4) using M6x10 Bolts (Ax4pc) as shown.

9

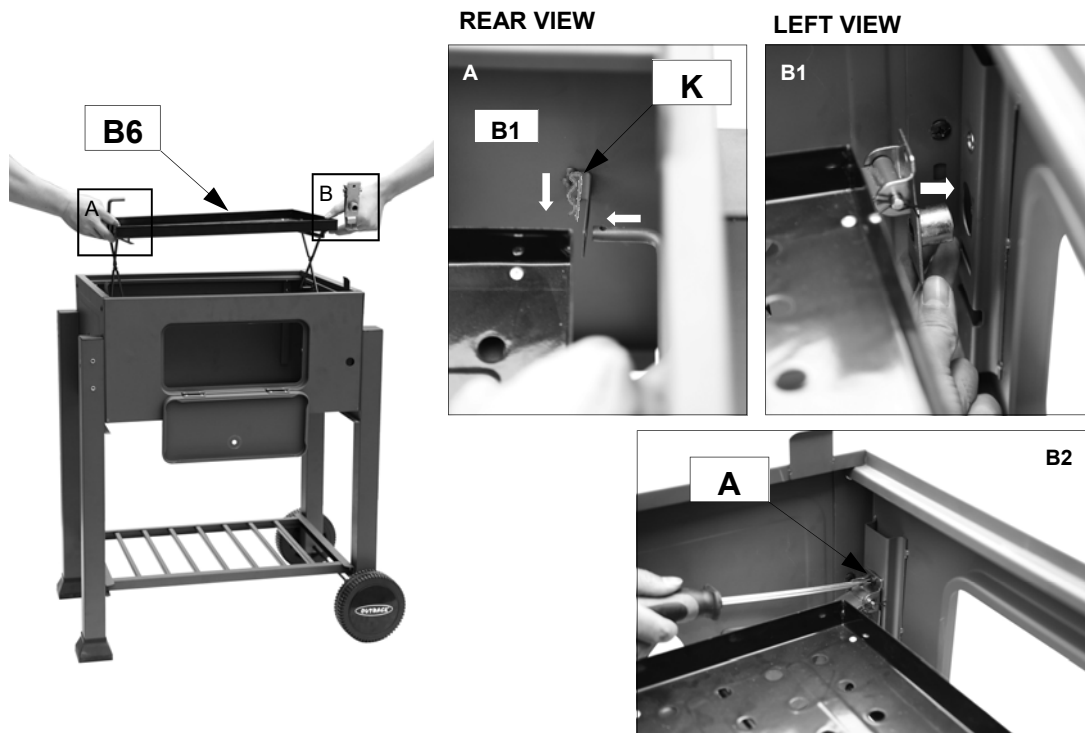

Carefully place the Adjustable Charcoal Pan (B6) into the fix box assembly, and fix using Cotter Pin (Kx1pc) and M6x10 Bolt (Ax1pcs) as shown.

10

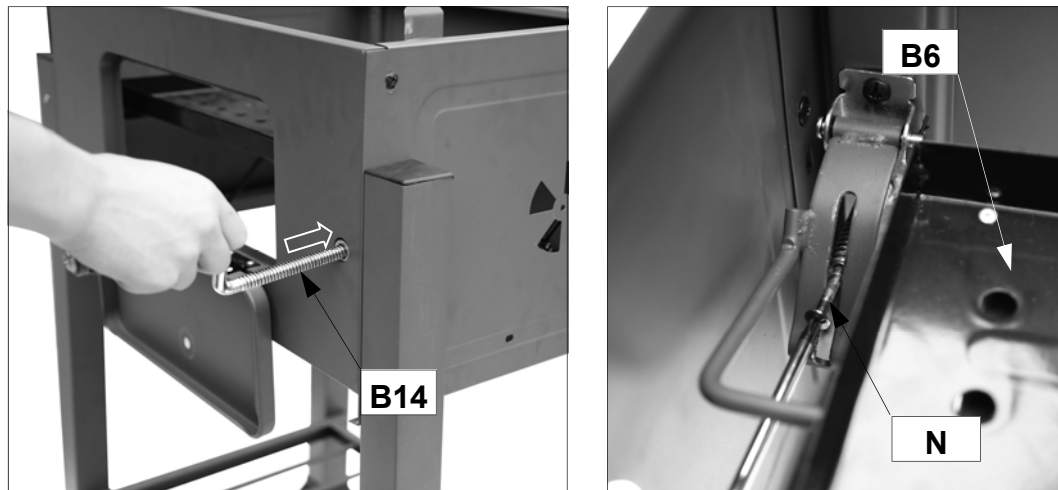

Attach the Charcoal Pan Handle (B14) to the adjusting lever of Charcoal Pan (B6) using M5x28 Half Screw Thread Bolt (Nx1pcs) as shown.

11

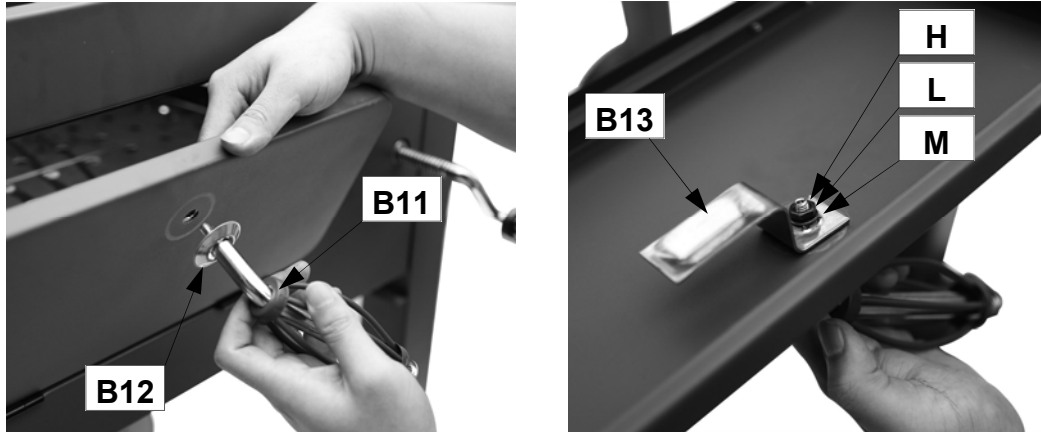

Attach the Charcoal Door Handle (B11) ,Charcoal Door Handle Base (B12) and Charcoal Door Locking Lever (B13) to the Charcoal Door using M6 Nut (Hx1pcs), D6 Washer (DLx1pc) and D6 Spring Washer (Mx1pc) as shown.

12

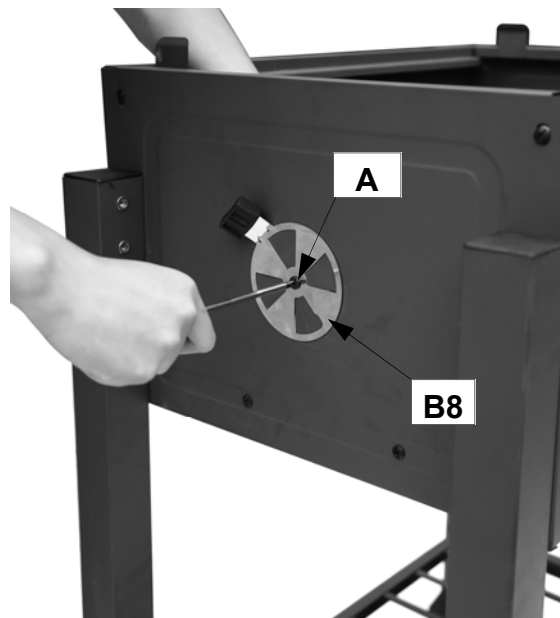

Attach the Air Vent (B8x2pcs) to the Fix Box Left Panel (B3) and Right Panel (B4) using M6x10 Bolts (Ax2pcs), M6 Nut (Hx2pcs), D6 Washer (Lx2pc) and D6 Spring Washer (Mx2pc) as shown.

13

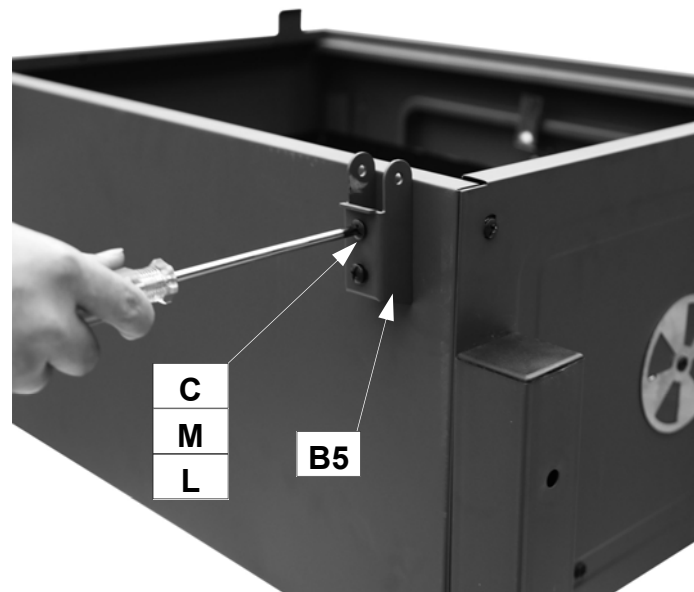

Attach the Lower Hinges (B5x2pcs) to the Fix Box Back Panel (B2) using M6x45 Bolts (Cx4pcs), D6 Spring Washer (Mx4pc) and D6 Washer (Lx4pc) as shown.

14

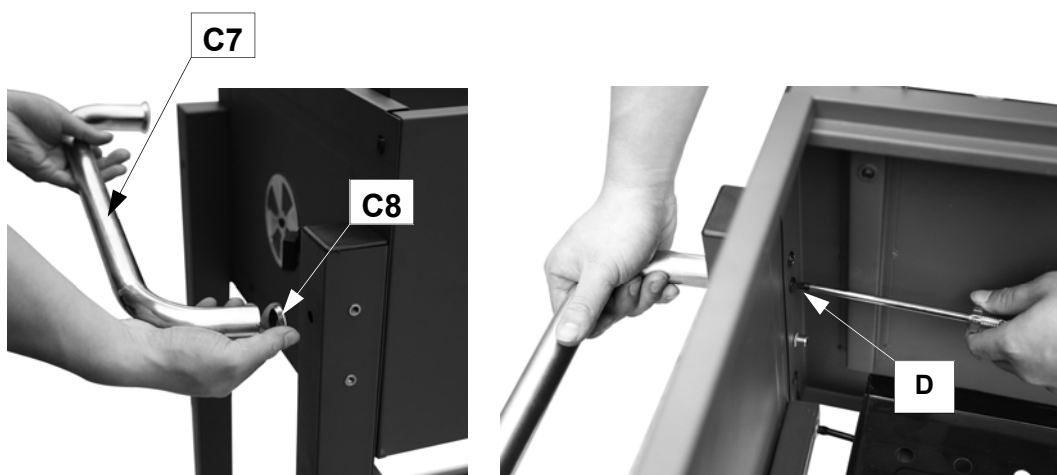

Attach the Cart Handle (C7) and Cart Handle Base (C8) to the Left Legs (C1,C2) using M6x70 Bolts (Dx2pcs) as shown.

Note: Adjust the charcoal pan to the lowest position to easy assembly of the cart handle.

15

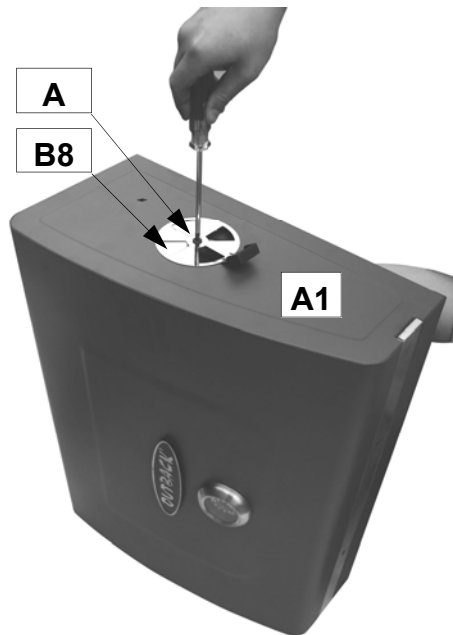

Attach the Air Vents (B8x2pcs) to the Hood (A1) using M6x10 Bolts (Ax2pcs), M6 Nut (Hx2pcs), D6 Washer (Lx2pc) and D6 Spring Washer (Mx2pc) as shown.

16

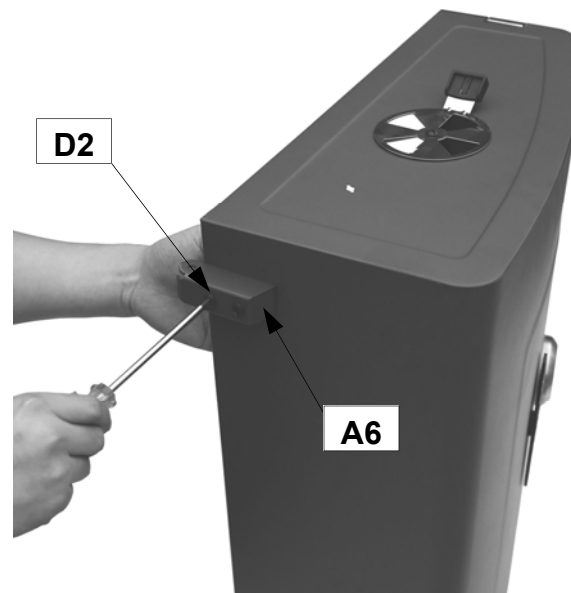

Attach the Upper Hinges (A6x2pcs) to the Hood (A1) using M6x35 Bolts (Bx4pcs), M6 Nuts (Hx4pcs), D6 Spring Washer (Mx4pc) and D6 Washer (Lx4pc) as shown.

17

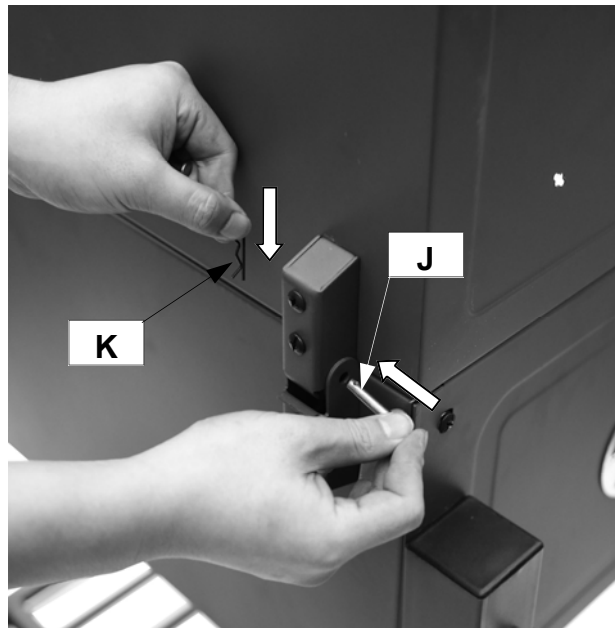

Insert the Hinge Pin (Jx2pcs) to the hole of Hinge, and fix using the Cotter Pin (Kx2pcs)

18

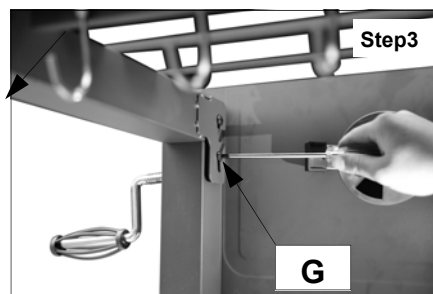
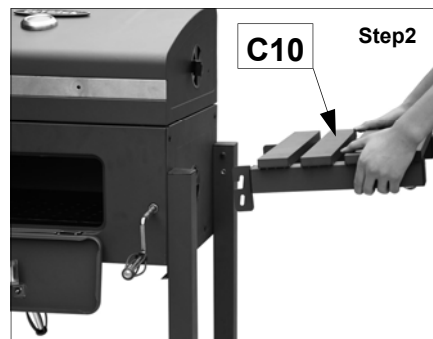
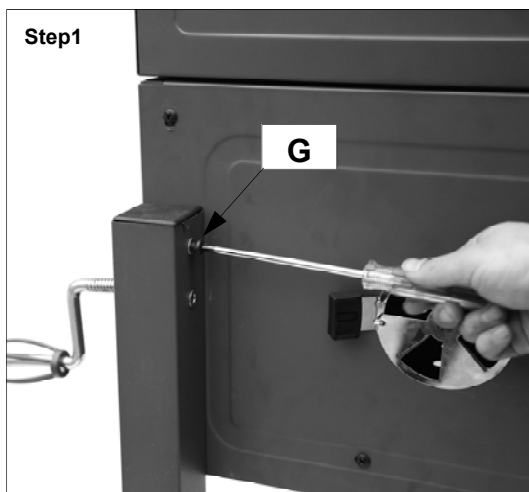

Attach the Right Side Table with Hooks (C10) to the Right Legs (C3,C4) using M6 Half Screw Thread Bolts (Gx4pcs) as shown.

19

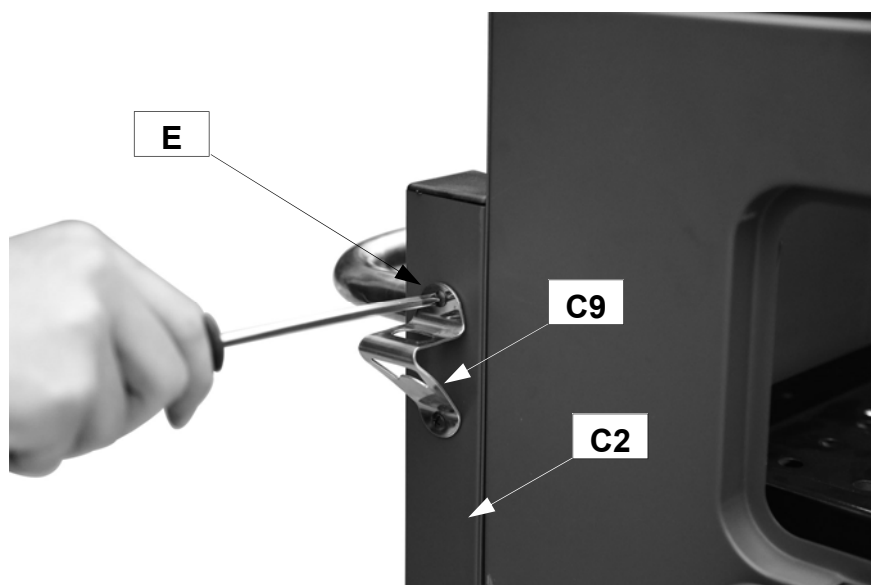

Attach the Bottle Opener (C9) to the Left Front Leg (C2) using the M5x16 Bolt (Ex2pcs) as shown.

Note: If the holes in the bottle opener do not match up to the holes in the leg of the BBQ, merely place the top screw in first and do not tighten, then place the bottom screw. Tighten both screws.

20

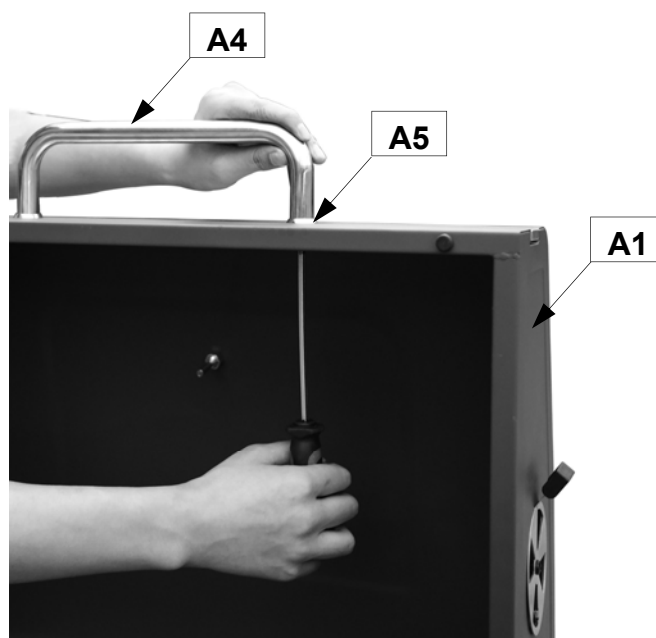

Attach the Hood Handle (A4) and Hood Handle Base (A5) to the Hood (A1) using M5x28 Bolts (Fx2pcs) as shown.

21

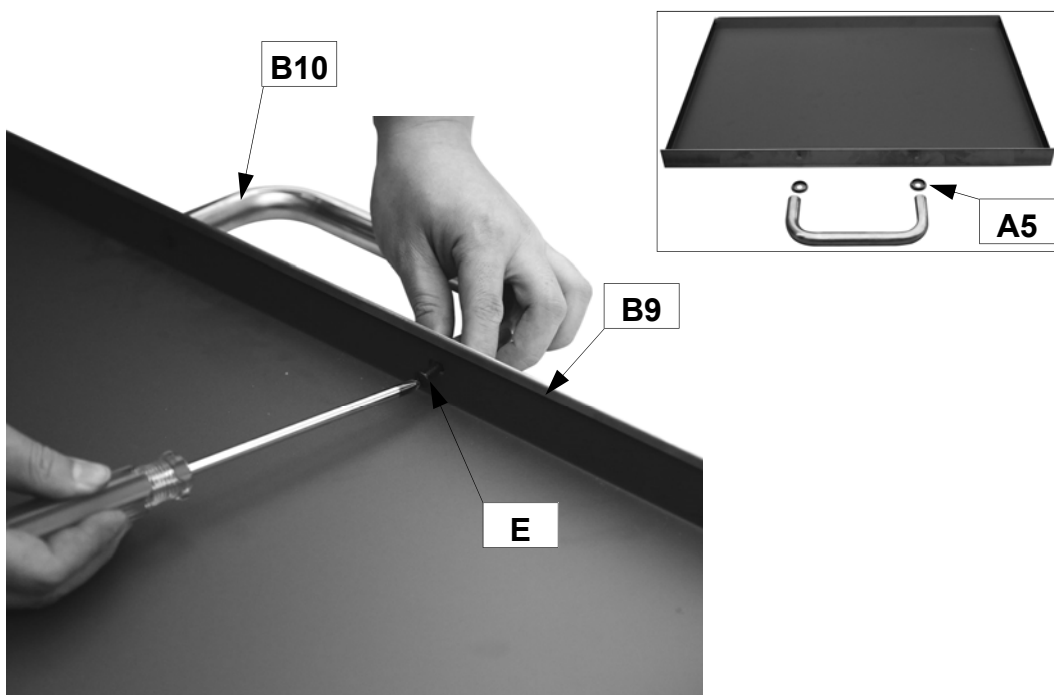

Attach the Ash Pan Handle (B10) and Ash Pan Handle Base (A5) to the Ash Pan (B9) using M5x16 Bolts (Ex2pcs) as shown.

22



Insert the Ash Pan (B9) by sliding it underneath the barbecue body.

23



Attach the Warming Rack (A7) to the Hood and Fix Box Assembly as shown.

24



Lay the Cooking Grid (B7) into place.
ASSEMBLY IS NOW COMPLETE.
PROCEED TO THE NEXT PAGE FOR INSTRUCTIONS ON OPERATION AND MAINTENANCE.

Important Information

Please read these instructions carefully before assembly and use of your barbecue.

- ▲ Retain these instructions for future reference.
- ▲ This product is for outdoors use only. Do not use indoors.
- ▲ Remove plastic wrap from any part before lighting.
- ▲ Do not use within 1m of any flammable structure or surface. Do not use under any combustible surface.
- ▲ Open the barbecue hood or lid before lighting.
- ▲ Once lit, do not move the barbecue until it has completely cooled, after use.
- ▲ This barbecue must not be left unattended when lit.
- ▲ The hood or lid handle can become very hot. Grip only the centre of the handle. Always use oven gloves when cooking or carrying out any adjustments to the barbecue.
- ▲ Always use the grill lifting handle and ash tray / vent tool provided.
- ▲ Use purpose designed barbecue tools with long, heat resistant handles.
- ▲ Use caution when opening the hood or lid, as hot steam inside is released upon opening.
- ▲ Parts of this barbecue become very hot – care must be taken, especially when children, elderly people, and animals are present.
- ▲ Never cover a barbecue until it has completely cooled.
- ▲ Use this barbecue only on a stable, flat surface.
- ▲ Do not store flammable materials near this barbecue.
- ▲ Do not use aerosols near this barbecue.
- ▲ Failure to follow the manual's instructions could result in serious injury or damage.
- ▲ Modification of the barbecue may be dangerous, is not permitted and will nullify any warranty.
- ▲ **WARNING!** Do not use spirit or petrol for lighting or re-lighting! Use only firelighters complying to EN1860-3. Do not add starter fluid to charcoal that is already alight.
- ▲ Do not use in high winds. Hot embers could be blown out of the barbecue and cause damage or serious injury.
- ▲ Always place charcoal in the charcoal grill,

not the ash tray.

- ▲ Ensure the ash tray is in place before use.
- ▲ Do not move the cooking grill and charcoal grill until after the appliance has completely cooled down.
- ▲ Parts sealed by the manufacturer or his agent must not be altered by the user.
- ▲ Never remove the ash tray whilst the barbecue is in use. Wait until the barbecue is completely cooled before removing it.
- ▲ If you have any queries regarding these instructions, contact your local dealer.

Installation

Selecting a Location

This barbecue is for **outdoor use only** and should be placed in a well-ventilated area, and on a safe and even surface. Never place your barbecue below ground level. Take care to ensure that it is not placed **UNDER** any combustible surface. The sides of the barbecue should **NEVER** be closer than 1 metre from any combustible surface, including trees and fences and that there are no heat sources near the barbecue (cigarettes, open flames, spark etc.). Keep this barbecue away from any flammable materials!

Precautions

Do not obstruct any ventilation openings in the barbecue body.

Operation

Warnings

- ▲ Before proceeding, make certain that you understand the **IMPORTANT INFORMATION** section of this manual.
- ▲ Your barbecue is not designed to be used with any part of the cooking area as a solid plate — this includes baking dishes. Full coverage will cause excessive build-up of heat and damage the barbecue. This is not covered by warranty.
- This barbecue is designed for charcoal use only. It is not designed to be used with lump wood charcoal, including lump wood based lighting bags, as it burns too quickly. We recommend the use of charcoal briquettes.
- Use only enough briquettes to cover the charcoal grill in a single layer. Do not overload the charcoal grill.
- The maximum amount of briquettes to be

used at any one time is 2.0kg.

- When placing charcoal, never allow charcoal to be closer than 5cm to the surrounding sides of the barbecue body.

Preparation Before Cooking

To prevent foods from sticking to the cooking surface, please use a long handled brush to **apply a light coat of cooking or vegetable oil before each barbecuing session.** (Note: When cooking for the first time, paint colours may change slightly as a result. This is normal and should be expected.)

Lining the Ash Tray

Line the ash tray with aluminium foil. This will protect the tray, help better reflect heat, and make cleaning easier when barbecuing is finished.

Starting the Charcoal

- Open the barbecue hood or lid before lighting. Never light your barbecue with the hood or lid closed.
- Take the barbecue grills out of the barbecue body.
- Block Type Starters – Form charcoal in a pyramid around it. Light the starter block. When charcoal is well lit, using a heat resistant tool, spread the charcoal around the grid, adding more as necessary.
- Liquid Starters – Place charcoal in a shallow tin. Pour liquid starter onto charcoal and wait 5-10 minutes to allow the starter to penetrate into the charcoal. Then using a heat resistant tool, place charcoal onto the grid in a pyramid formation.
- Light the charcoal and allow time for it to become well lit (red hot). Using a heat resistant tool, spread charcoal in a uniform layer, so that each lump is just touching.
- The barbecue grills can now be replaced. Be careful to keep yourself safely away from lit charcoal.
- When the charcoal is ashed over (grey coating of ash over each lump) you are ready to begin cooking.
- It is recommended to operate the barbecue with red-hot charcoal for at least 30 minutes before use.
- Do not begin cooking until charcoal has an ashed-over coat.
- Do not attempt to cook whilst charcoal is flaming.

Heat Control

The adjustable vents in the hood and ash tray can be used to control the burning of the charcoal. With the vents open, more air will circulate and the charcoal will burn faster than with the vents closed. Caution—the appliance may become very hot. Oven gloves and ash tray / vent tool should always be used when adjusting the vents. Do not close the hood or lid whilst the charcoal is still flaming. Wait until it has ashed over.

Grill Cooking

The food on the grill is cooked by the heat produced from the hot charcoal below. The natural food juices produced during cooking fall onto the hot charcoal below and vaporise. The subsequent rising smoke bastes the food, as it travels upwards, imparting that unique barbecued flavour.

Roasting Hood Cooking

Barbecues equipped with a roasting hood give the option to form an 'oven' for roasting or baking food, such as joints of meat or whole chickens, etc. More even cooking of food will actually be achieved by using the barbecue with the hood down.

Close the hood to cook the food 'indirectly'. Avoid lifting the hood unnecessarily as heat is lost every time the hood is opened. If the hood is opened during cooking please allow extra time for the barbecue to regain its temperature and complete the cooking. Use the temperature gauge (if applicable) to monitor the heat of the barbecue.

DO NOT ALLOW YOUR BARBECUE TO OVERHEAT. Take care when opening the hood as hot steam can be released on opening.

Flare-Up Control ** Very Important Notice **

Flare-ups occur when meat is barbecued and its fat and juices fall upon the hot charcoal. Smoke of course helps give food its barbecued flavour, but it is best to avoid excessive flare-up to prevent food being burned. To control flare-ups, it is **ABSOLUTELY ESSENTIAL** to trim away excess fat from meat and poultry before grilling, use cooking sauces and marinades sparingly and try to avoid very cheap cuts of meat or meat products as these tend to have a high fat and water content.

When flare-ups do occur, they can usually be extinguished by applying baking soda or a salt

directly onto the charcoal. Always protect your hands when handling anything near the cooking surface of the barbecue and take care to protect yourself from the flames.

If a fat fire occurs, please see the instructions given below.

Fat Fires

Empty and clean the ash tray of food debris after each cooking session. If the barbecue is to be used for large gatherings, additional care will be required to ensure excessive build up of fat does not occur and cause a fat fire. The time between cleaning may need to be reduced if very fatty foods or cheap meat products are being cooked. Failure to do this may result in a fat fire, which may cause injury and could seriously damage the barbecue.

In the event of a fat fire:

- Keep everyone at a safe distance from the barbecue and wait until the fire has burnt out.
- Do not close the hood or lid of the barbecue.
- NEVER DOUSE A BARBECUE WITH WATER. IF AN EXTINGUISHER IS USED, IT SHOULD BE A POWDER TYPE.
- DO NOT REMOVE THE ASH TRAY.
- If the fire does not seem to be abating or appears to be worsening, contact your local Fire Brigade for assistance.

Replenishing the Charcoal

To replenish the charcoal during use, remove the food from the cooking grill. With protected hands, use the grill lifting handle provided to raise up the foldable section of the grill. After adding the charcoal, carefully replace the grill, and continue cooking when the charcoal is ready.

End of Cooking Session

Ash can be shaken from the charcoal basket where it will drop into the ash tray. Ash should not be disposed of until you are certain it is cold and will not be able to re-ignite. Dispose of any unburned charcoal and remove remaining residue with a brass wire brush.

Wait until the barbecue is sufficiently cool before closing its hood or lid.

Care and Maintenance

Regularly clean your barbecue between uses and especially after extended periods of

storage. Ensure the barbecue and its components are sufficiently cool before cleaning. Do not leave the barbecue exposed to outside weather conditions or stored in damp, moist areas.

- ▲ Never handle hot parts with unprotected hands.
- ▲ Never douse the barbecue with water when its surfaces are hot.

In order to extend the life and maintain the condition of your barbecue, we strongly recommend that the unit be covered when left outside for any length of time, especially during the winter months. Heavy-duty barbecue covers and other accessories are available from your local stockist.

Even when your barbecue is covered for its protection, it must be inspected on a regular basis as damp or condensation can form which may result in damage to the barbecue. It may be necessary to dry the barbecue and the inside of the cover. It is possible for mould to grow on any fat remaining on parts of the barbecue. This should be cleaned off smooth surfaces with hot soapy water.

Any rust that is found that does not come into contact with the food should be treated with a rust inhibitor and painted with barbecue paint or a heat resistant paint.

A chrome cleaner may be used on chrome parts if required. To prevent rusting, wipe chrome plated parts with cooking oil after rinsing and drying.

Cooking Surfaces

When the barbecue has cooled, clean with hot soapy water. To remove any food residue, use a mild cream cleaner on a non-abrasive pad. Do not use scouring pads or powders as they can permanently damage the finish. Rinse well and dry thoroughly. Due to the weight of the cooking surfaces, we do not recommend cleaning in a dishwasher.

Ash Tray

After every use, empty and clean the ash tray of any fat or food particles, using a plastic or wooden scraper if necessary.

Discard the ash and foil, and wash any remaining ash or fat from the tray.

Failure to keep it clean, and excessive build up

can result in a fat fire. This can be hazardous and severely damage the barbecue. **This is not a fault in the barbecue and is therefore not covered by the terms of the warranty.** If required, the tray can be washed in hot soapy water.

Barbecue Body

Regularly remove excess grease or fat from the barbecue body using a cloth wrung out in hot soapy water and dry thoroughly. Excess fat and food debris can be removed from inside the body using a soft plastic or wooden scraper. It is not necessary to remove all the grease from the body. If you need to clean fully, use hot soapy water and a cloth, or nylon-bristled brush only. Do not use abrasives. Remove cooking surfaces before full cleaning.

Barbecue Hood or Lid & Trolley

Use a non-abrasive cloth or pad and clean with hot, soapy water. Do not use scouring pads or powders as they can permanently damage the finish.

Fixings

All screws and bolts, etc. should be checked and tightened on a regular basis.

Storage

Ensure the barbecue is properly cooled before covering or storing. Store your barbecue in a cool dry place.

When using the barbecue after extended periods of storage follow the cleaning procedures.

Specifications subject to change without prior notice

Notes:

Manufacturer:
TPA Industrial (DG) Co. Ltd.
Xingguang Rd., Huangjiang, Dongguan
Guangdong, China 523768

OUTBACK® WARRANTY

OUTBACK® barbecues are warranted to the original purchaser against defects in materials and workmanship. OUTBACK® will supply replacements for defective parts free of charge provided that:

- ◆ The product has not been used for trade, professional or hire purposes.
- ◆ The product has not been subjected to misuse or neglect, including fat fires and flare ups or use of a faulty or incorrect regulator.
- ◆ The product has not sustained damage through foreign objects, substances or accidents.
- ◆ The care and maintenance instructions given in your OUTBACK® manual have been followed.

Any warranty and guarantee claims shall be rendered void in the event of improper use of the barbecue or the use of non-approved fuels. Discolouration, rusting or slight deformation of parts exposed directly to the flames (grill, griddle, flame tamer, burner, etc.) do not impair the function of the barbecue and do not form a basis for any claims.

This warranty is offered as an extra benefit and is in addition to the customers' statutory rights.

OUTBACK® does not in any way warranty the gas cylinder.

In the unlikely event that you experience problems with this barbecue, please fill in our warranty form at:

<http://www.outbackbarbecues.com/warranty-form>

One of our colleagues will be in contact with you shortly.

For reference and correspondence, record your serial number here.
(See sticker on side of barbecue body.)

Serial No. _____

This number may be required when ordering spare parts or accessories. A part reference number may also be required where applicable.

HELPLINE NUMBER: 0345 388 6032