



## Assembly and Operating Instructions for Outback® Senator 6 Burner Gas BBQ



Photographs are not to scale.  
Specifications subject to change  
without prior notice.

MS5661AW

CE 0359



### WARNING

- For outdoor use only. Not for commercial use.
- Read instructions before using the appliance. Failure to follow instructions could result in death, serious bodily injury, and/or property loss.
- Warning: accessible parts may be very hot. Keep young children and pets away.
- Do not move the appliance during use.
- Turn off the gas supply at the gas bottle after use.
- Any modification of the appliance, misuse, or failure to follow the instructions may be dangerous and will invalidate your warranty. This does not affect your statutory rights.
- Retain these instructions for future reference.
- Leak test annually, and whenever the gas bottle is removed or replaced. Check that the hose connections are tight and leak test each time you reconnect the gas bottle.
- For Flare-up control please refer to the 'OPERATION' section of this manual.

### FOR YOUR SAFETY

If you smell gas:

1. Shut off gas to the appliance.
2. Extinguish any open flame.
3. Open barbecue lid or hood.
4. If odour continues, discontinue use and contact your local dealer.

### FOR YOUR SAFETY

1. Do not store or use petrol or other flammable vapours or liquids in the vicinity of this or any other appliance.
2. A gas bottle not connected for use shall not be stored in the vicinity of this or any other appliance.

## Parts List

Quantities vary according to model purchased. Specifications subject to change without prior notice. For more details on hardware, please see 'Hardware Reference Diagram'.

	CODE	PART	QTY	Senator 6 Burner Gas BBQ
HOOD	A1	Hood ( <i>Pre-Assembled to Body</i> )	1	✓+
	A2	Hood Handle	1	✓+
	A3	Heat Indicator	1	✓+
	A4	Warming Rack	1	✓
BODY	B1	Barbecue Body	1	✓+
	B2	Burner	6	✓+
	B3	Cross Channel	5	✓+
	B4	Control Panel	1	✓+
	B5	Knob	6	✓+
	B6	Flame Tamer	6	✓
	B7	Cooking Grill	2	✓
	B8	Round Cooking Grill	1	✓
	B9	Drip Tray Handle	1	✓
	B10	Drip Tray	1	✓
	B11	Drip Tray Left Bracket	1	✓
	B12	Drip Tray Right Bracket	1	✓
	B13	Side burner valve, Hose and Regulator Assembly	1	✓+
	B14	Main Burner Electrode Wire	1	✓+
TROLLEY	C1	Side Burner Shelf	1	✓
	C2	Side Burner Shelf Front Panel	1	✓
	C3	Side Burner Grid	1	✓
	C4	Side Burner Knob	1	✓
	C5	Knob Bezel	1	✓
	C6	Side Burner	1	✓
	C7	Side Burner Electrode Wire	1	✓+
	C8	Ignition Button	1	✓
	C9	Side Shelf	1	✓
	C10	Side Shelf Front Panel	1	✓
	C11	Tool Hook	1	✓
	C12	Left Cabinet Panel	1	✓
	C13	Right Cabinet Panel	1	✓
	C14	Upper Support	1	✓
	C15	Left Door	1	✓
	C16	Right Door	1	✓
	C17	Door Handle	2	✓+
	C18	Rear Panel	1	✓
	C19	Bottom Panel	1	✓
	C20	Magnet	2	✓
	C21	Axle	1	✓
	C22	Wheel	2	✓
	C23	Hubcap	2	✓
	C24	Locknut	2	✓+
HARDWARE	D1	ST4.0x10 Screw	21	✓
	D2	M4x10 Bolt	3	✓
	D3	M4x15 Bolt	4	✓
	D4	Washer	4	✓
	D5	M4 Nut	4	✓
	D6	M6x15 Bolt	22	✓
	D7	M6x65 Bolt	4	✓
	D8	M6 Nut	10	✓
+ Pre-Assembled Component				

# Parts Diagrams

Quantities vary according to model purchased. Specifications subject to change without prior notice. For more details on hardware, please see hardware pack page.

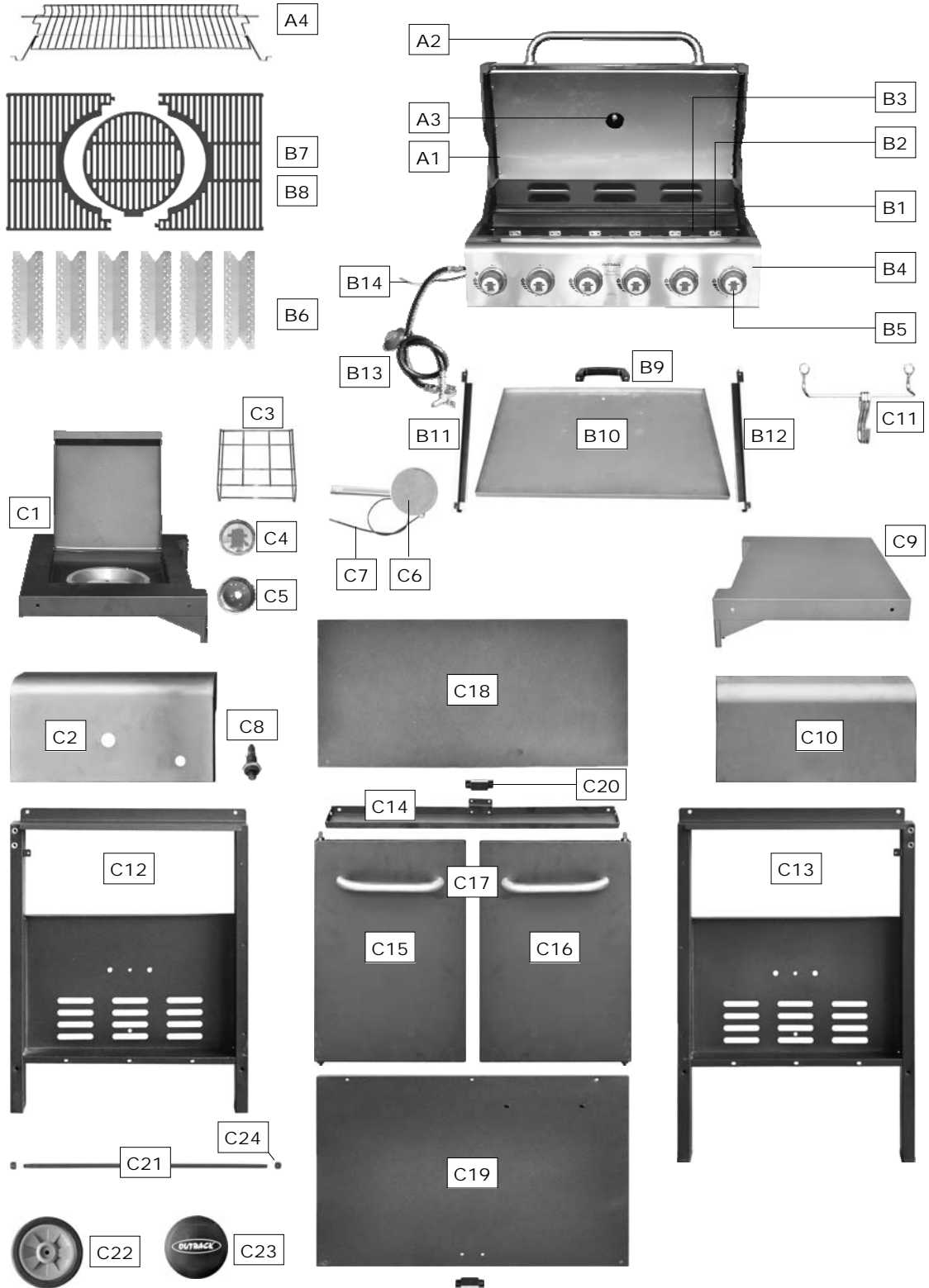

# Hardware Reference Diagram

Specifications subject to change without prior notice.

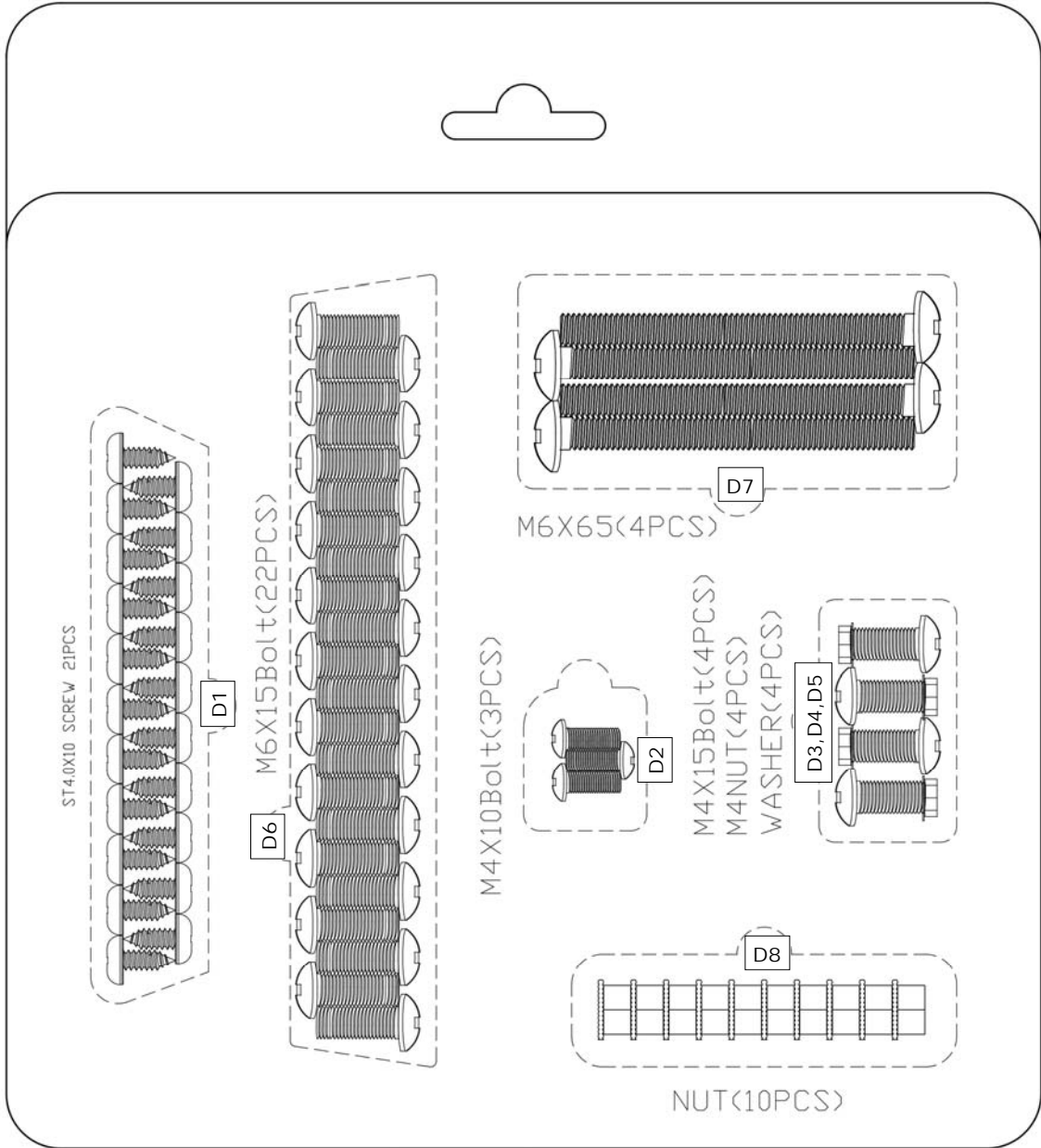

## Assembly

### IMPORTANT!

- **TOOLS NEEDED FOR ASSEMBLY:** Medium size flat blade or Phillips/Crosspoint screwdriver, adjustable spanner or metric spanner set.
- Remove any internal components or packaging from the barbecue body.
- Whilst every care is taken in the manufacture of this product, care must be taken during assembly in case sharp edges are present.
- **Please read the Important Information section carefully before assembly and use of your barbecue.**

1

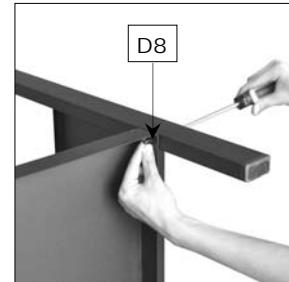
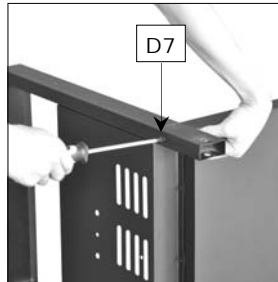
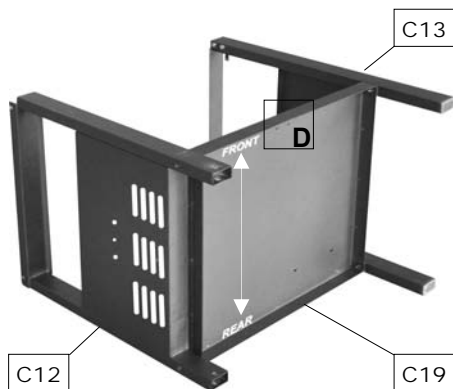

**Note:** Ensure that the holes to install magnet should be at the front of the bottom panel as showed in figure D.

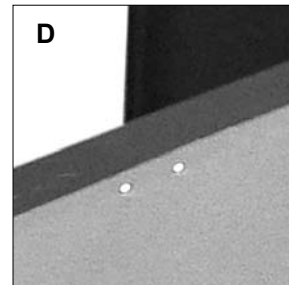

Attach the Left Cabinet Panel (C12) and Right Cabinet Panel (C13) to the Bottom Panel (C19) using the M6x65 Bolts (D7x4pcs) and M6 Nuts (D8x4pcs).

2

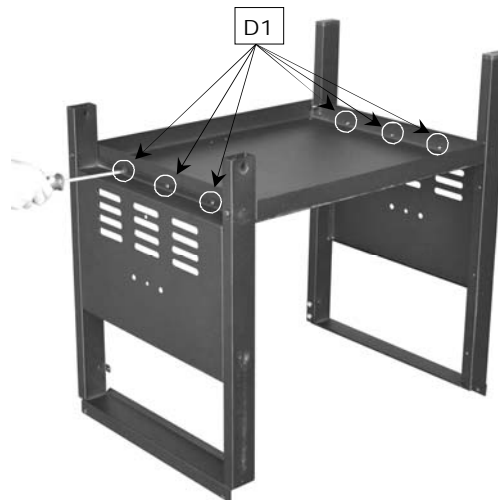

Complete fixing the left cabinet panel and right cabinet panel onto bottom panel using the ST4.0x10 Screw (D1x6pcs) as shown.

3

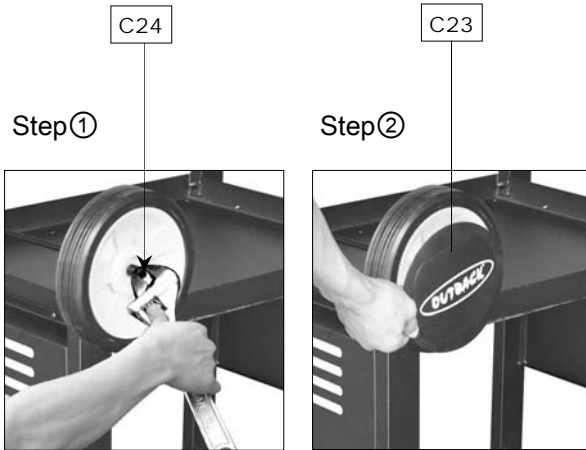

Unscrew the Locknuts (C24) from both ends of the Axle (C21).

Insert the axle through the corresponding holes in the left legs, then slide a Wheel (C22) over each end of the axle. Secure the wheels into place with the locknuts.

Place the Hubcaps (C23) onto the outside of the wheels.

4

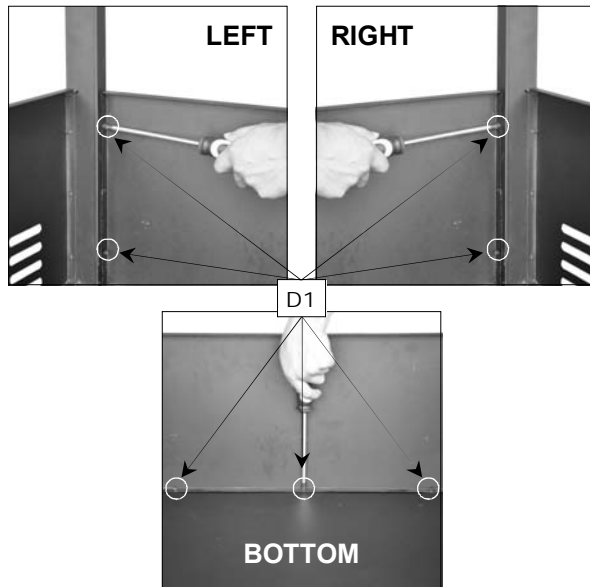
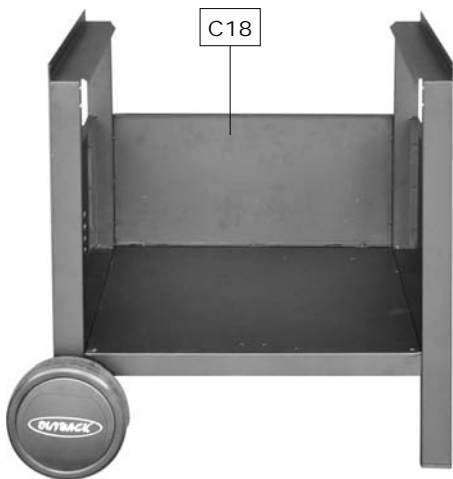

Carefully turn the assembled cabinet right side up.

Install the Rear Panel (C18) in position using the ST4.0x10 Screw (D1x7pcs) as shown.

5

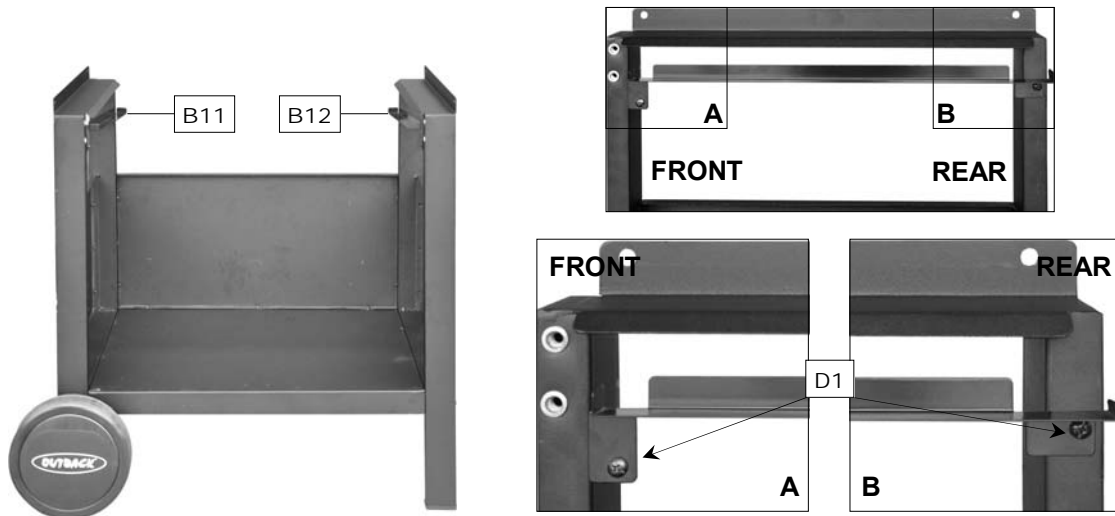

Attach the Drip Tray Left Bracket (B11) to the left legs using ST4.0x10 Screws (D1x2pcs) as shown. Repeat above process for Drip Tray Right Bracket (B12).

6

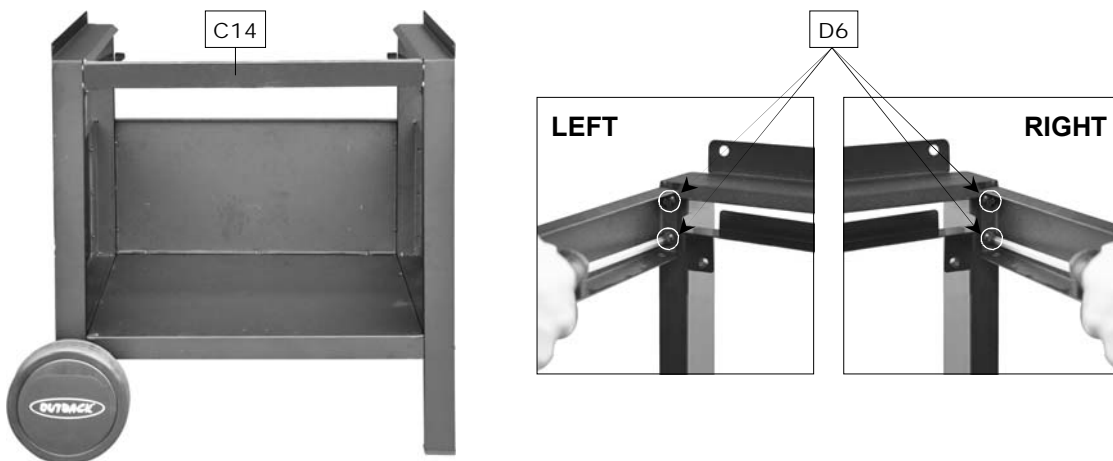

Attach the Upper Support (C14) between the front legs using M6x15 Bolts (D6x4pcs).

7

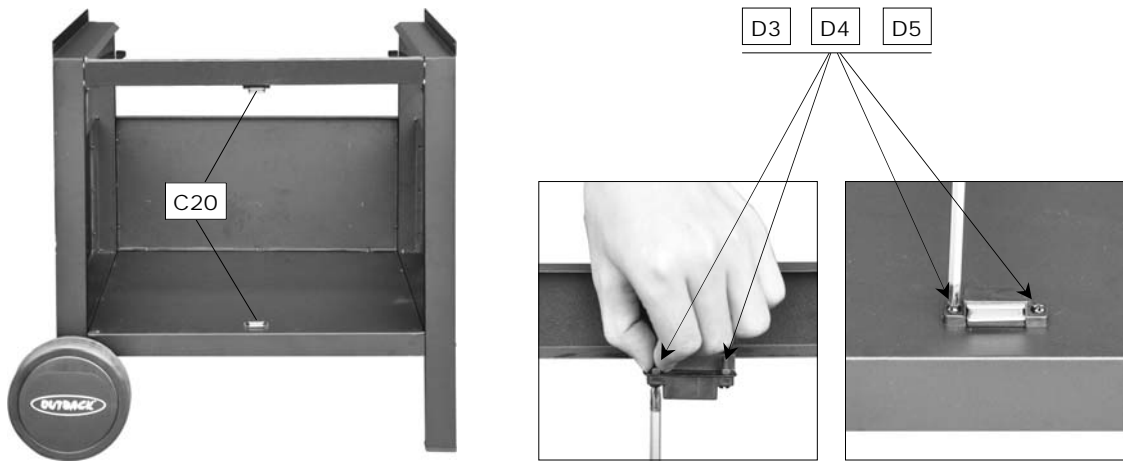

Attach the Magnets (C20) onto the bottom panel and upper support using M4x15 Bolts (D3x4pcs), Washer (D4x4pcs) and M4 Nuts (D5x4pcs) as shown.

8

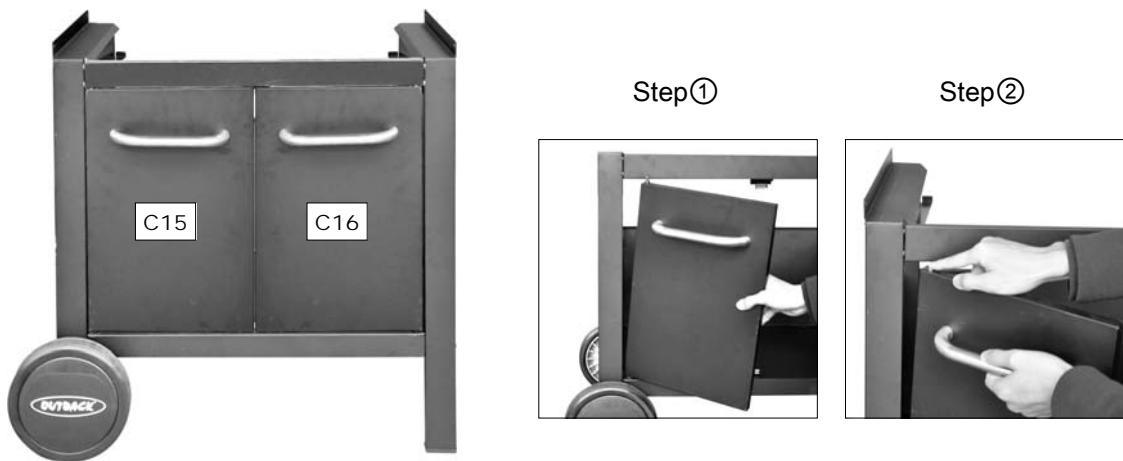

Fit the Left Door (C15) and Right Door (C16) to the cabinet by depressing the spring pins and placing into the cabinet, as shown.



9

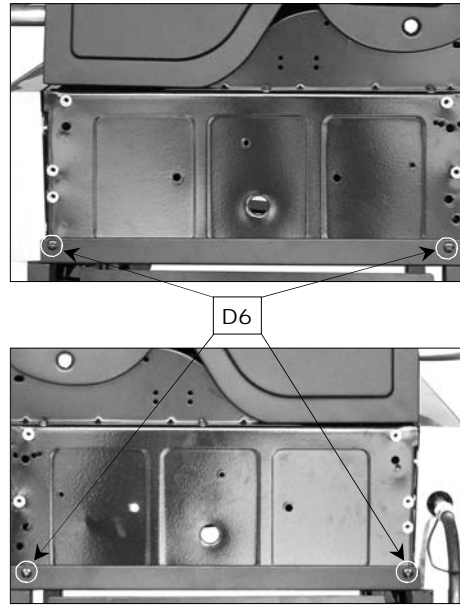
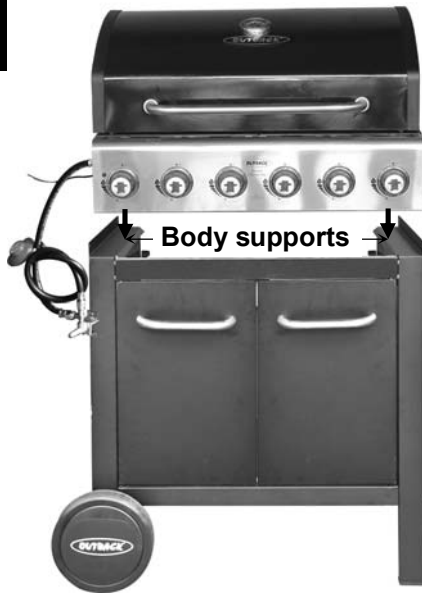

Carefully place the Barbecue Body (B1) onto the body supports and fix it by using M6x15 Bolts (D6x4pcs) as shown.

**WARNING: DO NOT RELEASE THE BARBECUE BODY WHILE THE BARBECUE HAS NOT BEEN PROPERLY SEATED. THIS MAY RESULT IN INJURY OR DAMAGE TO YOUR BARBECUE.**

**CAUTION!** Care must be taken to ensure the hood or lid does not fall open unexpectedly or become damaged when it is set on the ground.

10

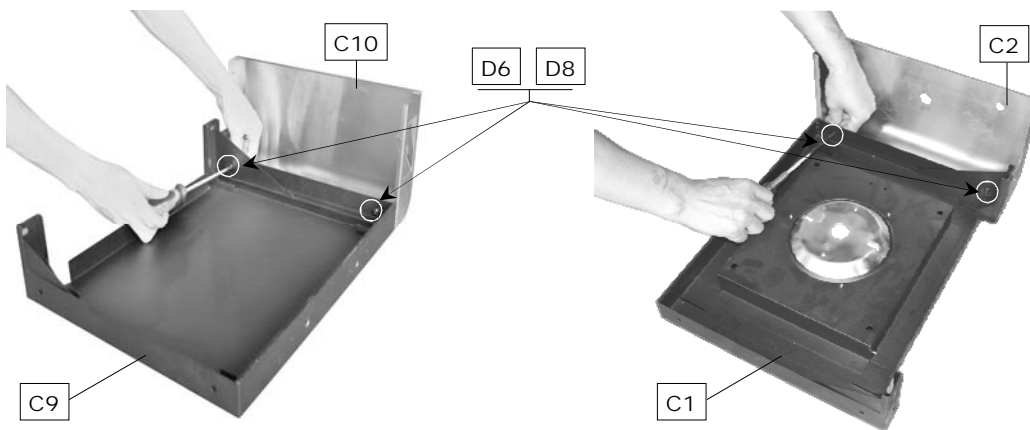

Attach Side Shelf Front Panel (C10) onto the Side Shelf (C9) using M6x15 Bolts (D6x2pcs) and M6 Nuts (D8x2pcs).

Attach Side Burner Shelf Front Panel (C2) onto the Side Burner Shelf (C1) using M6x15 Bolts (D6x2pcs) and M6 Nuts (D8x2pcs).

11

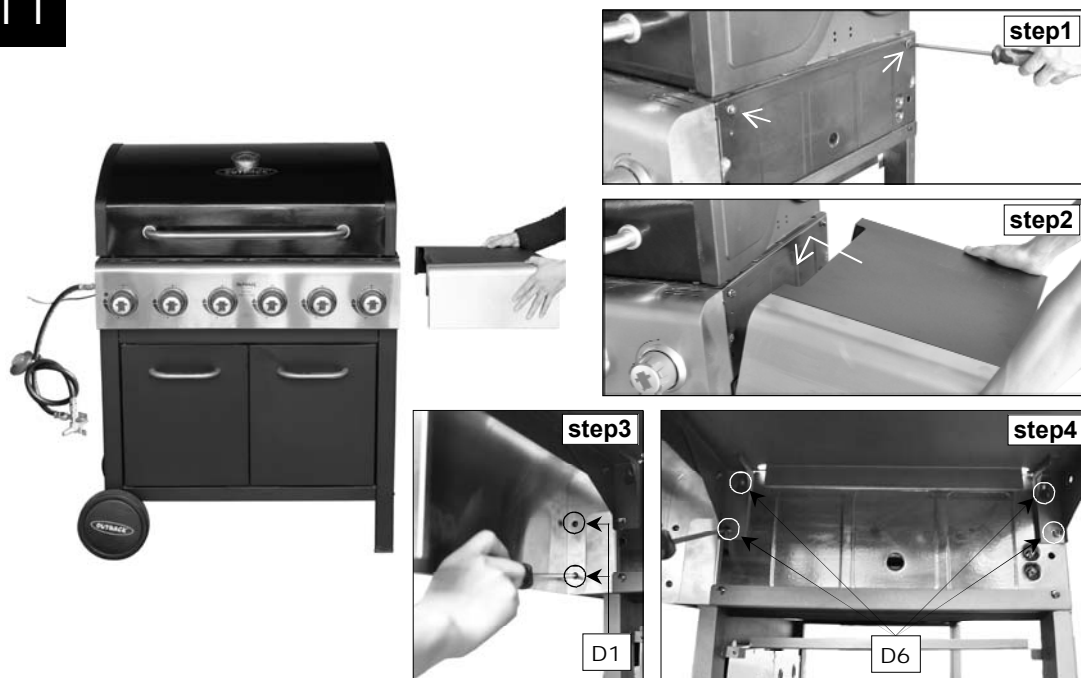

Attach the side shelf assembly to the barbecue body using ST4.0x10 Screws (D1x2pcs) and M6x15 Bolts (D6x4pcs) as shown.

12

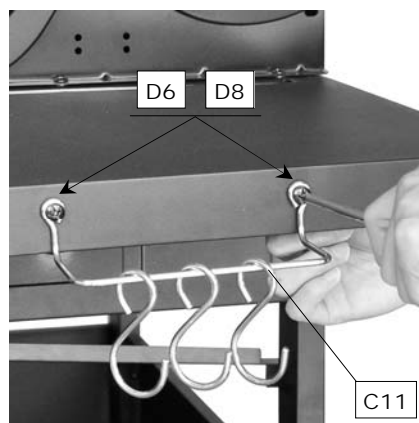

Attach the Tool Hook (C11) onto the side shelf using M6x15 Bolts (D6x2pcs) and M6 Nut (D8x2pcs) as shown.

13

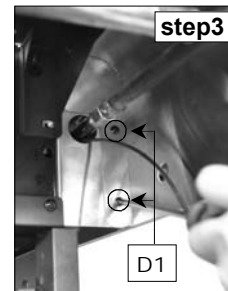
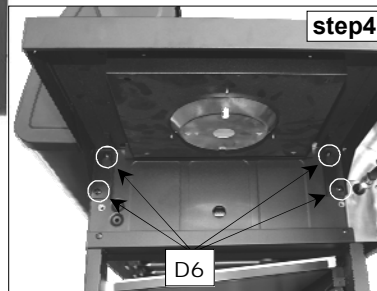
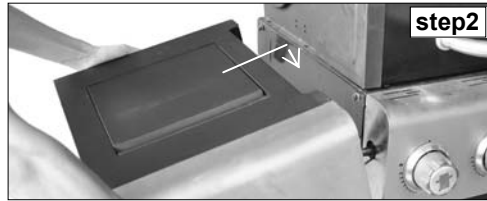
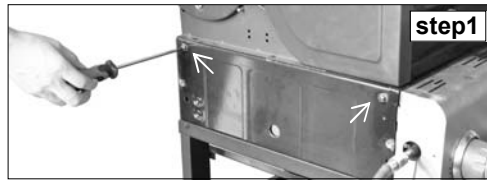

Attach the side burner shelf assembly to the barbecue body using ST4.0x10 Screws (D1x2pcs) and M6x15 Bolts (D6x4pcs) as shown.

14

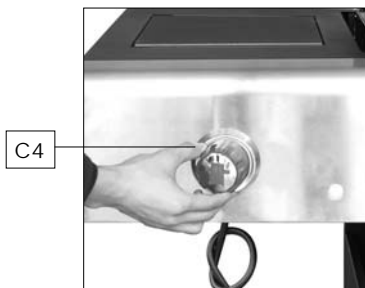
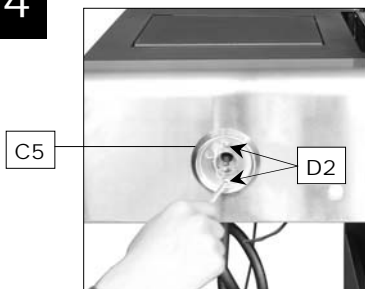

Attach the side burner valve and Knob Bezel (C5) onto side burner shelf using M4x10 Bolts (D2x2pcs) as shown. Press the Side Burner Knob (C4) onto side burner valve stem.

15

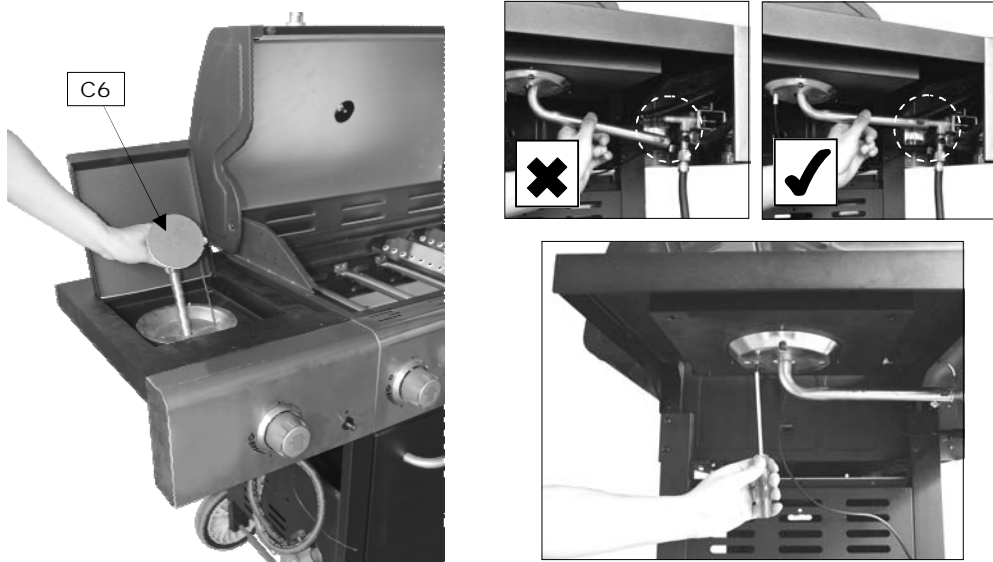

Feed the venturi tube of the Side Burner (C6) through the hole in bottom of the side burner shelf, and fix side it onto side burner shelf using a M4x10 Bolt (D2) as shown. Make sure that the end of venturi tube is set over the gas outlet of side burner valve.

16

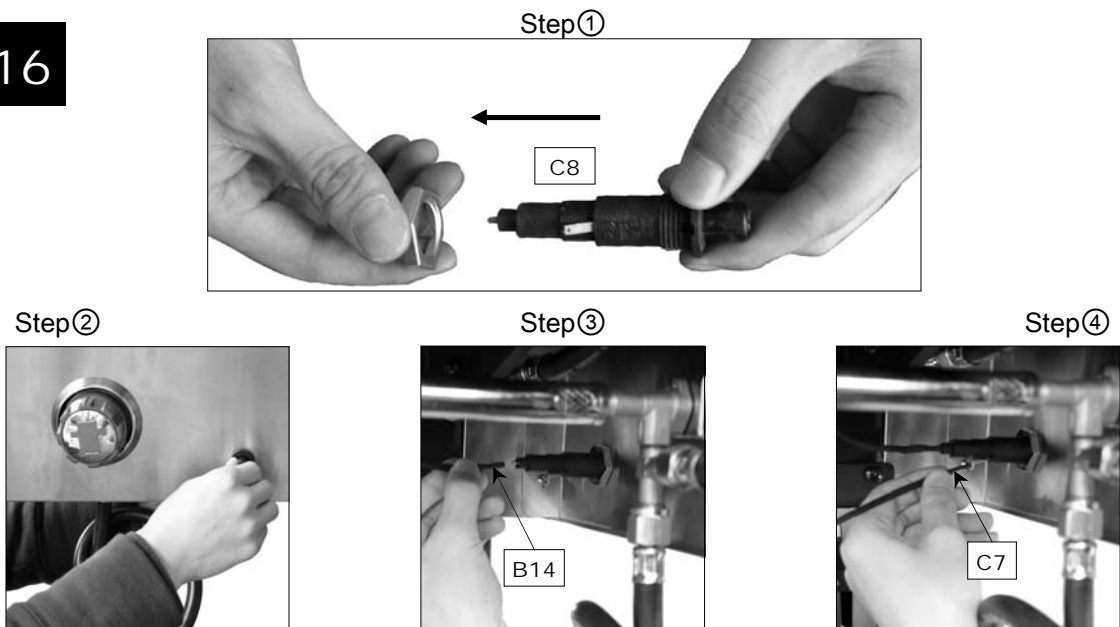

Unscrew the pre-assembled nut of the Ignition Button (C8).  
 Insert the ignition button through the hole at the side burner shelf panel and secure with the pre-assembled nut.  
 Connect the Main Burner Electrode Wire (B14) and Side Burner Electrode Wire (C7) to the ignition button as shown.

17

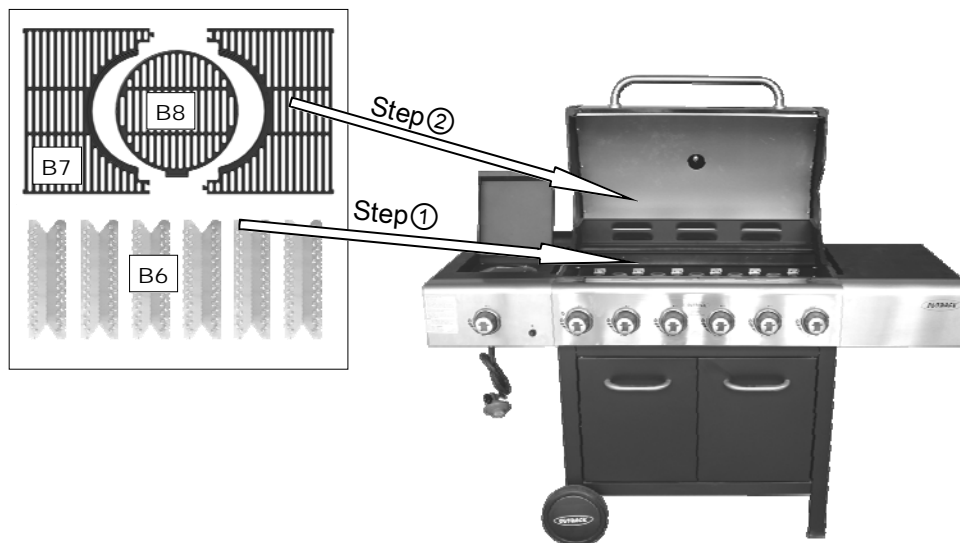

Carefully lay Flame Tamers (B6) into the barbecue body ensuring it lies level within the body. Lay the Cooking Grills (B7) and Round Grill (B8) into place.

**NOTE:** Ensure the cooking grill lies directly over the flame tamer on the barbecue body.

18



Place Side Burner Grid (C3) onto the Side burner shelf.

**Note:** Only use cookware with a base diameter of between 150mm and 220mm on the side burner.

19



LEFT

Step ①

Step ②

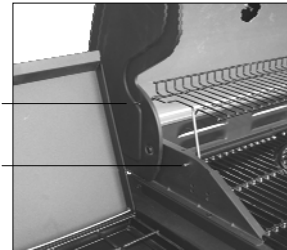

RIGHT

Step ③

Step ④

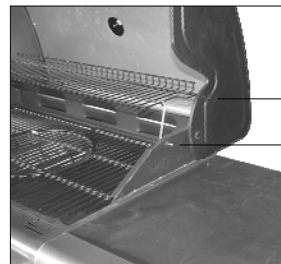

Attach the Warming Rack (A4) to the Hood (A1) and Barbecue Body (B1) as shown. Make sure that the swing legs fix to the body of the barbecue and the shorter fixed legs go through the holes in the hood.

20

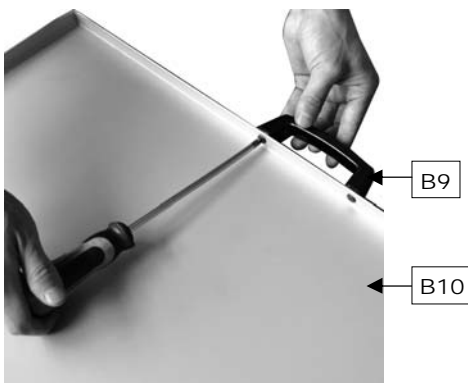

Remove the retaining bolts from Drip Tray Handle (B9), and then attach it onto the Drip Tray (B10) using the retaining bolts.

Insert the drip trap by sliding it underneath the barbecue body.

## Leak Test Diagram



1. Maximum diameter or breadth is 320mm.
2. Maximum height (regulator included) is 700mm.

**ASSEMBLY IS NOW COMPLETE.  
PROCEED TO THE NEXT PAGE FOR INSTRUCTIONS ON OPERATION AND  
MAINTENANCE**

ALL JOINTS AND CONNECTIONS MUST NOW BE **LEAK TESTED** BEFORE USING THE BARBECUE.

Leak test annually, and whenever the gas bottle is removed or replaced.

### **Leak Testing**

Always perform a leak test in a well-ventilated area.

**Step 1** - Confirm all control knobs are in the off position.

**Step 2** - Turn the gas on / open the gas control valve on the gas bottle or regulator.

**Step 3** - Check for leaks by brushing a solution of  $\frac{1}{2}$  water and  $\frac{1}{2}$  liquid detergent / soap over all the gas system joints, including gas bottle valve connections, hose connections, and regulator connections.

**Step 4** - NEVER USE AN OPEN FLAME to test for leaks at any time.

**Step 5** - If bubbles form over any of the joints there is a leak

- Turn off the gas supply at the gas bottle
- Retighten all joints
- Repeat test
- If bubbles form again do not use the barbecue and contact your local distributor for assistance.

Always wipe the mixed solution ( $\frac{1}{2}$  water and  $\frac{1}{2}$  liquid detergent / soap) from all joints and connections after leak testing.

## **Important Information**

**Please read these instructions carefully before assembly and use of your barbecue.**

- ▲ Retain these instructions for future reference.
- ▲ This product is for outdoor use only. Do not use indoors.
- ▲ Do not use the barbecue or store gas bottles below ground level. LP gas is heavier than air so if a leak occurs the gas will collect at a low level and could ignite in the presence of a flame or spark.
- ▲ For use with LPG bottled gas only. A suitable regulator must be used for butane, propane or mixes.
- ▲ Remove plastic wrap from any part before lighting.
- ▲ Do not use within 1m of any flammable structure or surface. Do not use under any combustible surface.
- ▲ LP gas bottles should never be placed directly underneath the barbecue.
- ▲ LP gas bottles should never be stored or used laid on their side, in the horizontal position. A leak would be very serious and liquid could enter the gas line with serious result.
- ▲ Never store gas bottles indoors.
- ▲ Open the barbecue hood before lighting.
- ▲ Once lit, do not move the barbecue until it has completely cooled, after use.
- ▲ This barbecue must not be left unattended when lit.
- ▲ The hood or lid handle can become very hot. Grip only the centre of the handle. Always use oven gloves when cooking or carrying out any adjustments to the barbecue.
- ▲ Use purpose designed barbecue tools with long, heat resistant handles.
- ▲ Use Caution when opening hood or lid, as hot steam inside is released upon opening.
- ▲ Parts of this barbecue become very hot – care must be taken, especially when children, elderly people, and animals are present.
- ▲ Turn off the gas supply at the gas bottle after use.
- ▲ Never cover a barbecue until it has completely cooled.
- ▲ Use this barbecue only on a stable, flat surface.
- ▲ Before you use your barbecue, perform a

leak test. This is the only safe and sure way to detect any gas leaking from joints and connections of the barbecue after assembly.

- ▲ Leak test annually, and whenever the gas bottle is removed or replaced.
- ▲ Do not store flammable materials near this barbecue.
- ▲ Do not use aerosols near this barbecue.
- ▲ Parts sealed by the manufacturer or his agent must not be altered by the user.
- ▲ Failure to follow the manual's instructions could result in serious injury or damage.
- ▲ Modification of the barbecue may be dangerous, is not permitted and will nullify any warranty.
- ▲ If you have any queries regarding these instructions, contact your local dealer.

## **Gas, Regulator and Hose**

This barbecue includes a regulator which is suitable for use with Propane Patio Gas bottles. For optimal performance, we suggest to use a 13kg size gas bottle. Propane bottles will supply gas all year round, even on cold winter days. A spanner may be required to change gas bottles.

- The hose should hang freely with no bends, twisting, tension, folds, or kinks that could obstruct free flow of gas. Always inspect the hose for cuts, cracks, or excessive wear before use.
- Apart from the connection point, no part of the hose should touch any hot barbecue parts. If the hose shows any sign of damage it must be replaced with a hose suitable for use with LP gas which meets the national standards for the country of use.
- A suitable hose must comply with EN16436-1 or local regulation, and the length should not exceed 1.5 metres.

The regulator included with this barbecue complies with EN16129. YOU MUST HAVE THE PROPER REGULATOR AND GAS BOTTLE IN ORDER FOR THE BARBECUE TO OPERATE SAFELY AND EFFICIENTLY. USE OF AN INCORRECT OR FAULTY REGULATOR OR GAS BOTTLE IS DANGEROUS AND WILL INVALIDATE ANY WARRANTY. In the case of replacing your original hose and regulator, please consult your local gas dealer for the most suitable regulators and gas bottles.



## **Installation**

### **Selecting a Location**

This barbecue is for **outdoor use only** and should be placed in a well-ventilated area, and on a safe and even surface. Never place your barbecue below ground level. Take care to ensure that it is not placed UNDER any combustible surface. The sides of the barbecue should NEVER be closer than 1 metre from any combustible surface, including trees and fences and make sure that there are no heat sources near the barbecue (cigarettes, open flames, spark etc.). Keep this barbecue away from any flammable materials!

### **Precautions**

Do not obstruct any ventilation openings in the barbecue body.

Position the gas bottle on level ground next to the barbecue and safely away from any source of heat.

Should you need to install or change the gas bottle, confirm that the barbecue is switched off, and that there are no sources of ignition (cigarettes, open flame, sparks, etc.) near before proceeding.

### **Connecting a Gas Hose to the Barbecue**

Connect the gas hose to the gas rail inlet on the barbecue. Do not overtighten. Do not use any sealing tape, paste or liquid on the connection.

### **Fixing a Regulator to the Gas Bottle**

Confirm all barbecue control knobs are in the off position. Connect the regulator to the gas bottle according to your regulator and bottle dealer's instructions.

## **Operation**

### **▲ Warnings**

- ▲ Before proceeding, make certain that you understand the **IMPORTANT INFORMATION** section of this manual.
- ▲ Your barbecue is not designed to be used with more than 50% of the cooking area as a solid plate — this includes baking dishes. Full coverage will cause excessive build-up of heat and damage the barbecue. This is not covered by warranty.

### **Preparation Before Cooking**

To prevent foods from sticking to the cooking

surface, please use a long handled brush to **apply a light coat of cooking or vegetable oil before each barbecuing session.** (Note: When cooking for the first time, paint colours may change slightly as a result. This is normal and should be expected.) During use, the protective coating may come off the cooking surface. This is normal and is not harmful.

**Line the drip tray with aluminium foil, then place a uniform layer of clean, dry sand 6-8mm deep into the tray. This will absorb excess cooking fat, thus making cleanup easy.**

### **Lighting the Barbecue**

- Open the barbecue and side burner hood or lid before lighting. **Never** light your barbecue or side burner with the hood or lid closed.
- Ensure all knobs are in the off position. Open the gas control valve on the gas bottle or regulator.
- Push and turn the control knob of the leftmost burner to the high position. Press the ignition button rapidly several times until burner is lit.
- If burner fails to ignite after following above procedure, turn all the knobs to the off position. Close the gas valve on the gas bottle. Wait 5 minutes. Reattempt all of the above steps. If the barbecue still fails to light, please refer to the manual ignition instructions below.
- After successful lighting of the leftmost burner, ignite the remaining burners in sequence from left to right. Confirm each burner is alight before igniting another burner.
- After ignition, turn the burners to the high position for 3-5 minutes in order to pre-heat the barbecue. This should be done before each cooking session. The hood or lid should be open during preheating.
- After completion of preheating, turn all burners to the low position for best cooking results.

### **Manual lighting instructions**

- Open the barbecue and side burner hood or lid before lighting. **Never** light your barbecue or side burner with the hood or lid closed.
- Ensure all knobs are in the off position. Open the gas control valve on the gas bottle or regulator.
- Insert lit match through the right match-lighting hole on the right side of the barbecue body and place near rightmost

burner porthole.

- Push and turn the rightmost control knob anti-clockwise to the high position, taking care to protect yourself from the flames.
- When the right burner is lit, turn the remaining burners on from right to left.
- Confirm that each burner is alight before turning on the next burner.
- To light the side burner, place the lit end of a long match alongside the side burner. Push and turn the side burner knob anti-clockwise to the high position, taking care to protect yourself from the flames.
- If a burner fails to ignite, contact your local dealer for assistance.
- After ignition, turn the burners to the high position for 3-5 minutes in order to pre-heat the barbecue. This should be done before each cooking session. The hood or lid should be open during preheating.
- After completion of preheating, turn all burners to the low position for best cooking results.

### Grill Cooking

The burners heat up the flame tamers underneath the grill, which in turn heats the food on the grill. The natural food juices produced during cooking fall onto the flame tamers below and vaporise. The subsequent rising smoke bastes the food, as it travels upwards, imparting that unique barbecued flavour.

### Roasting Hood Cooking

Barbecues equipped with a roasting hood give the option to form an 'oven' for roasting or baking food, such as joints of meat or whole chickens, etc. More even cooking of food will actually be achieved by using the barbecue with the hood down. **However, this should only be done with the burners on low.**

For best results, place the food you wish to bake or roast on a metal baking tray and set it on one side of the cooking grill.

Turn the burner directly under the food to the OFF position and turn all other burners to a LOW to MEDIUM position.

Close the hood to cook the food 'indirectly'. Avoid lifting the hood unnecessarily as heat is lost every time the hood is opened. If the hood is opened during cooking please allow extra time for the barbecue to regain its temperature and complete the cooking. Use the temperature

gauge to monitor the heat of the barbecue.

If the internal heat becomes too high, turn the burners down to the low position. It is not necessary or advisable to have all of the burners on high when the hood is closed.

**DO NOT ALLOW YOUR BARBECUE TO OVERHEAT.** Be careful of hot steam when opening the hood.

### Warming Rack

Warming racks are a convenient way to keep cooked food warm or to warm items such as bread rolls. It is advisable to place food (particularly fatty foods) to the front of the warming rack to avoid the possibility of juices and fat running down the back of your barbecue. Always check that your warming rack is properly fitted before use.

### Flare-Up Control \*Very Important\*

Flare-ups occur when meat is barbecued, and its fat and juices fall upon the hot flame tamers. Smoke of course helps give food its barbecued flavour, but it is best to avoid excessive flare-up to prevent food being burned. To control flare-ups, it is **ABSOLUTELY ESSENTIAL** to trim away excess fat from meat and poultry before grilling, use cooking sauces and marinades sparingly and try to avoid very cheap cuts of meat or meat products as these tend to have a high fat and water content. Also, the burners should always be placed on the low setting during cooking.

When flare-ups do occur, they can usually be extinguished by applying baking soda or salt directly onto the flame tamers. Always protect your hands when handling anything near the cooking surface of the barbecue and take care to protect yourself from the flames.

If a fat fire occurs, please see the instructions given below.

### Fat Fires

Empty and clean the drip tray and drip pan of food debris after each cooking session. If the barbecue is to be used for large gatherings, it will be necessary to turn off and cool the barbecue every two hours to remove food debris from the drip tray and drip pan, and clean it out. The time between cleaning may need to be reduced if very fatty foods or cheap meat products are being cooked. Failure to do this may result in a fat fire, which may cause injury

and could seriously damage the barbecue.

#### **In the event of a fat fire:**

- If safe to do so, turn all control knobs to the 'off' position.
- Turn off the gas supply at the gas bottle.
- Keep everyone at a safe distance from the barbecue and wait until the fire has burnt out.
- Do not close the hood or lid of the barbecue.
- NEVER DOUSE A BARBECUE WITH WATER. IF AN EXTINGUISHER IS USED, IT SHOULD BE A POWDER TYPE.
- DO NOT REMOVE THE DRIP TRAY .
- If the fire does not seem to be abating or appears to be worsening, contact your local Fire Brigade for assistance.

#### **End of Cooking Session**

After each cooking session, turn the barbecue burners to the "high" position and burn for 5 minutes. This procedure will burn off cooking residue, thus making cleaning easier. Make sure the hood or lid is open during this process.

#### **Turning Off Your Barbecue**

When you have finished using your barbecue, turn all the control valves fully clockwise to the "Off" position, then switch off the gas supply at the bottle.

Wait until the barbecue is sufficiently cool before closing its hood.

## **Care and Maintenance**

Regularly clean your barbecue between uses and especially after extended periods of storage. Ensure the barbecue and its components are sufficiently cool before cleaning. Do not leave the barbecue exposed to outside weather conditions or stored in damp, moist areas.

- ▲ Never handle hot parts with unprotected hands.
- ▲ Never douse the barbecue with water when its surfaces are hot.

In order to extend the life and maintain the condition of your barbecue, we strongly recommend that the unit be covered when left outside for any length of time, especially during the winter months. Heavy-duty barbecue covers and other accessories are available from your local stockist.

Even when your barbecue is covered for its protection, it must be inspected on a regular basis as damp or condensation can form which may result in damage to the barbecue. It may be necessary to dry the barbecue and the inside of the cover. It is possible for mould to grow on any fat remaining on parts of the barbecue. This should be cleaned off smooth surfaces with hot soapy water.

Any rust that is found that does not come into contact with the food should be treated with a rust inhibitor and painted with barbecue paint or a heat resistant paint.

#### **Cooking Surfaces & Warming Rack**

When the barbecue has cooled, clean with hot soapy water. To remove any food residue, use a mild cream cleaner on a non-abrasive pad. Do not use scouring pads or powders as they can permanently damage the finish. Rinse well and dry thoroughly. Due to the weight of the cooking surfaces, we do not recommend cleaning in a dishwasher.

#### **Burner**

Provided that they are operating correctly, in normal usage, burning off the residue after cooking will keep the burners clean.

The burners should be removed and cleaned annually, or whenever heavy build-up is found, to ensure that there are no signs of blockage (debris, insects) in either the burner portholes or the primary air inlet of the burners. Use a pipe cleaner to clear obstructions.

When refitting the burners, be careful to check that the neck of the burner fits over the valve outlet.

It is quite normal for surface rust to be present on the burners. If rust appears between uses or in storage, clean with a soft brass wire brush.

#### **Flame Tamer**

Remove any food residue from the flame tamer surface with a plastic or wooden scraper or brass wire brush. Do not use a steel scraper or wire brush. Clean with hot soapy water and rinse well.

#### **Drip Tray**

After every use, empty and clean the drip tray (and foil liner, if applicable) of any fat or food particles, using a plastic or wooden scraper if necessary.

Failure to keep it clean, and excessive build up can result in a fat fire. This can be hazardous and severely damage the barbecue. **This is not a fault in the barbecue and is therefore not covered by the terms of the warranty.** If required, the tray can be washed in hot soapy water.

#### **Barbecue Body**

Regularly remove excess grease or fat from the barbecue body using a cloth wrung out in hot soapy water and dry thoroughly. Excess fat and food debris can be removed from inside the body using a soft plastic or wooden scraper. It is not necessary to remove all the grease from the body. If you need to clean fully, use hot soapy water and a cloth, or nylon-bristled brush only. Do not use abrasives. Remove cooking surfaces and burners before full cleaning. Do not immerse the gas controls or manifold in water. Check burner operation after carefully refitting into body.

#### **Barbecue Hood or Lid & Trolley**

Use a non-abrasive cloth or pad and clean with hot, soapy water. Do not use scouring pads or powders as they can permanently damage the finish.

#### **Stainless Steel**

Stainless Steel is a type of steel containing chromium, which offers high resistance to corrosion and heat by forming a protective layer of Chromium Oxide. Exposure to fat, dirt and water can prevent the protective layer being formed, which can lead to spotting such as surface discolouration and rust.

Stainless steel surfaces can be cleaned using a stainless steel cleaner or methylated spirits and any spotting should be taken care of immediately. Failure to remove spotting can lead to permanent discolouration.

- ▲ Never use a chlorine based cleaner on stainless steel.
- ▲ Do not use a wire brush, steel wool or abrasives as these will strip the protective layer, which can lead to rusting.
- ▲ Always rinse and allow to dry after cleaning.

#### **Fixings**

All screws and bolts, etc. should be checked and tightened on a regular basis.

#### **Storage**

Ensure the barbecue is properly cooled before

covering or storing. Store your barbecue in a cool dry place.

Cover the burners with aluminium foil in order to prevent insects or other debris from collecting in burner holes.

If the barbecue is to be stored indoors, the gas bottle must be disconnected and left outside. The gas bottle should always be stored outside, in a dry, well-ventilated area, away from any sources of heat or ignition. Do not let children tamper with the bottle.

When using the barbecue after extended periods of storage follow the cleaning procedures.

## Technical Specifications

	CE Approval	Heat Input	Burners	Injector Size	Gas Consumption
<b>Senator 6 Burner Gas BBQ</b>	0359 359BR665	17.28 Kw	6	0.84mm	Butane: 1258g/hr Propane: 1235g/hr
<b>Side Burner</b>		2.94 kW	1	0.84mm	Butane: 214g/hr Propane: 210g/hr

**Category:** I<sub>3+</sub> (28-30/37)

**Gas / Pressure:** G30 Butane at 28-30mbar and G31 Propane at 37mbar

**Countries of Use:** BE, CH, CY, CZ, ES, FR, GB, GR, IE, IT, LT, LU, LV, PT, SK, SI

**Category:** I<sub>3B/P(30)</sub>

**Gas / Pressure:** G30 Butane and G31 Propane at 30mbar

**Countries of Use:** AL, BG, CY, CZ, DK, EE, FI, FR, HR, HU, IS, IT, LT, LU, MK, MT, NL, NO, RO, SE, SI, SK, TR

Specifications are subject to change without prior notice.

## Notes:

## **Troubleshooting**

<b>Problem</b>	<b>Possible Cause</b>	<b>Solution</b>
<b>Burner will not light using the ignition system</b>	LP gas bottle is empty	Replace with full bottle
	Faulty regulator	Have regulator checked or replaced
	Obstructions in burner	Clean burner
	Obstructions in gas jets or gas hose	Clean jets and gas hose
	Electrode or ignition button wire is loose or disconnected on electrode or ignition unit	Reconnect wire
	Electrode or wire is damaged	Change electrode and wire
	Faulty ignition button	Change ignitor and / or button
<b>Burner will not light with a match</b>	LP gas bottle is empty	Replace with full bottle
	Faulty regulator	Have regulator checked or replaced
	Obstructions in burner	Clean burner
	Obstructions in gas jets or gas hose	Clean jets and gas hose
<b>Low flame or flashback (fire in burner tube— a hissing or roaring noise may be heard)</b>	LP gas bottle too small	Use larger bottle
	Obstructions in burner	Clean burner
	Obstructions in gas jets or gas hose	Clean jets and gas hose
	Windy conditions	Use barbecue in a more sheltered position
<b>Gas valve knob difficult to turn</b>	Gas valve jammed	Replace gas valve

Manufacturer:  
 TPA Industrial (DG) Co. Ltd.  
 Xingguang Rd., Huangjiang, Dongguan  
 Guangdong, China 523768

## OUTBACK® WARRANTY

OUTBACK® barbecues are warranted to the original purchaser against defects in materials and workmanship:

- ◆ Porcelain coated roasting hoods and stainless steel roasting hoods are warranted for a period of two (2) years from the date of purchase.
- ◆ Stainless steel burners and cast iron burners are warranted for a period of two (2) years from the date of purchase.
- ◆ Other parts are warranted for a period of one (1) year from the date of purchase.

OUTBACK® will, within above periods, supply replacements for defective parts free of charge provided that:

- ◆ The product has not been used for trade, professional or hire purposes.
- ◆ The product has not been subjected to misuse or neglect, including fat fires and flare ups or use of a faulty or incorrect regulator.
- ◆ The product has not sustained damage through foreign objects, substances or accidents.
- ◆ The care and maintenance instructions given in your Outback manual have been followed.

If the product includes one or a number of parts or accessories, only the defective accessory or part will be replaced i.e. Hose, Regulator, Rotisserie, Piezo Ignitor, Roast Hood and Side Burner.

Fat fires are not covered under warranty.

Any warranty & guarantee claims shall be rendered void in the event of improper use of the BBQ or the use of non approved fuels, discolouration , rusting or slight deformation of parts exposed directly to the flames ( grill / griddle / flame tamers / burners ,etc ) do not impair the function of the BBQ and do not form a basis for any claims.

This warranty is offered as an extra benefit and is in addition to the customers' statutory rights.

OUTBACK® does not in any way warranty the gas cylinder.

In the unlikely event that you experience problems with this barbecue, please fill in our warranty form at:

<http://www.outbackbarbecues.com/warranty-form>

One of our colleagues will be in contact with you shortly.

For reference and correspondence, record your serial number here.  
(See sticker on side of barbecue body.)

**Serial No.** \_\_\_\_\_

This number may be required when ordering spare parts or accessories. A part reference number may also be required where applicable.

HELPLINE NUMBER: 0345 388 6032