



Assembly and Operating Instructions for Outback® Magnum 3 Gas BBQ



RC4341PC

Photographs are not to scale.
Specifications subject to change
without prior notice.

CE 0359



WARNING

- For outdoor use only. Not for commercial use.
- Read instructions before using the appliance. Failure to follow instructions could result in death, serious bodily injury, and/or property loss.
- Warning: accessible parts may be very hot. Keep young children and pets away.
- Do not move the appliance during use.
- Turn off the gas supply at the gas bottle after use.
- Any modification of the appliance, misuse, or failure to follow the instructions may be dangerous and will invalidate your warranty. This does not affect your statutory rights.
- Retain these instructions for future reference.
- Leak test annually, and whenever the gas bottle is removed or replaced. Check that the hose connections are tight and leak test each time you reconnect the gas bottle.
- For Flare-up control please refer to the 'OPERATION' section of this manual.

FOR YOUR SAFETY

If you smell gas:

1. Shut off gas to the appliance.
2. Extinguish any open flame.
3. Open barbecue lid or hood.
4. If odour continues, discontinue use and contact your local dealer.

FOR YOUR SAFETY

1. Do not store or use petrol or other flammable vapours or liquids in the vicinity of this or any other appliance.
2. A gas bottle not connected for use shall not be stored in the vicinity of this or any other appliance.

Parts List

Quantities vary according to model purchased. Specifications subject to change without prior notice. For more details on hardware, please see 'Hardware Reference Diagram'.

	CODE	PART	QTY	Magnum 3 Gas BBQ
HOOD	A1	Hood (<i>Pre-Assembled to Body</i>)	1	✓+
	A2	Hood Handle	1	✓+
	A3	Heat Indicator	1	✓+
	A4	Warming Rack	1	✓
BODY	B1	Cooking Grill	2	✓
	B2	Round Grill	1	✓
	B3	Flame Tamer	3	✓
	B4	Charcoal Basket	1	✓
	B5	Barbecue Body	1	✓
	B6	Knob	3	✓+
	B7	Control Panel	1	✓+
	B8	Burner	3	✓+
	B9	Drip Tray	1	✓
	B10	Drip Tray Left Bracket	1	✓
	B11	Drip Tray Right Bracket	1	✓
	B12	Hose and Regulator Assembly	1	✓+
TROLLEY	C1	Side Burner Shelf	1	✓
	C2	Side Burner Base	1	✓
	C3	Side Burner Ignition Pushbutton	1	✓
	C4	Side Burner	1	✓
	C5	Side Burner Electrode	1	✓
	C6	Side Burner Grid	1	✓
	C7	Side Burner Knob	1	✓
	C8	Side Shelf	1	✓
	C9	Tool Hook Support	1	✓
	C10	Tool Hook	3	✓
	C11	Left Front Leg	1	✓
	C12	Left Rear Leg	1	✓
	C13	Right Front Leg	1	✓
	C14	Right Rear Leg	1	✓
	C15	Bottle Opener	1	✓
	C16	Front Screen	1	✓
	C17	Trolley Base	1	✓
	C18	Axle	1	✓
	C19	Wheel	2	✓
	C20	Hubcap	2	✓
HARDWARE	D1	M5x15 Bolt	4	✓
	D2	M5 Washer	4	✓
	D3	M5 Nut	4	✓
	D4	M6x10 Bolt	19	✓
	D5	M6x15 Bolt	12	✓
	D6	M6x145 Bolt	8	✓
	D7	Washer	8	✓
	D8	M6 Nut	4	✓
	D9	M4x10 Bolt	2	✓
	D10	Locknut	2	✓+
	D11	Wing Nut	1	✓+
+ Pre-Assembled Component				

Parts Diagrams

Quantities vary according to model purchased. Specifications subject to change without prior notice. For more details on hardware, please see hardware pack page.

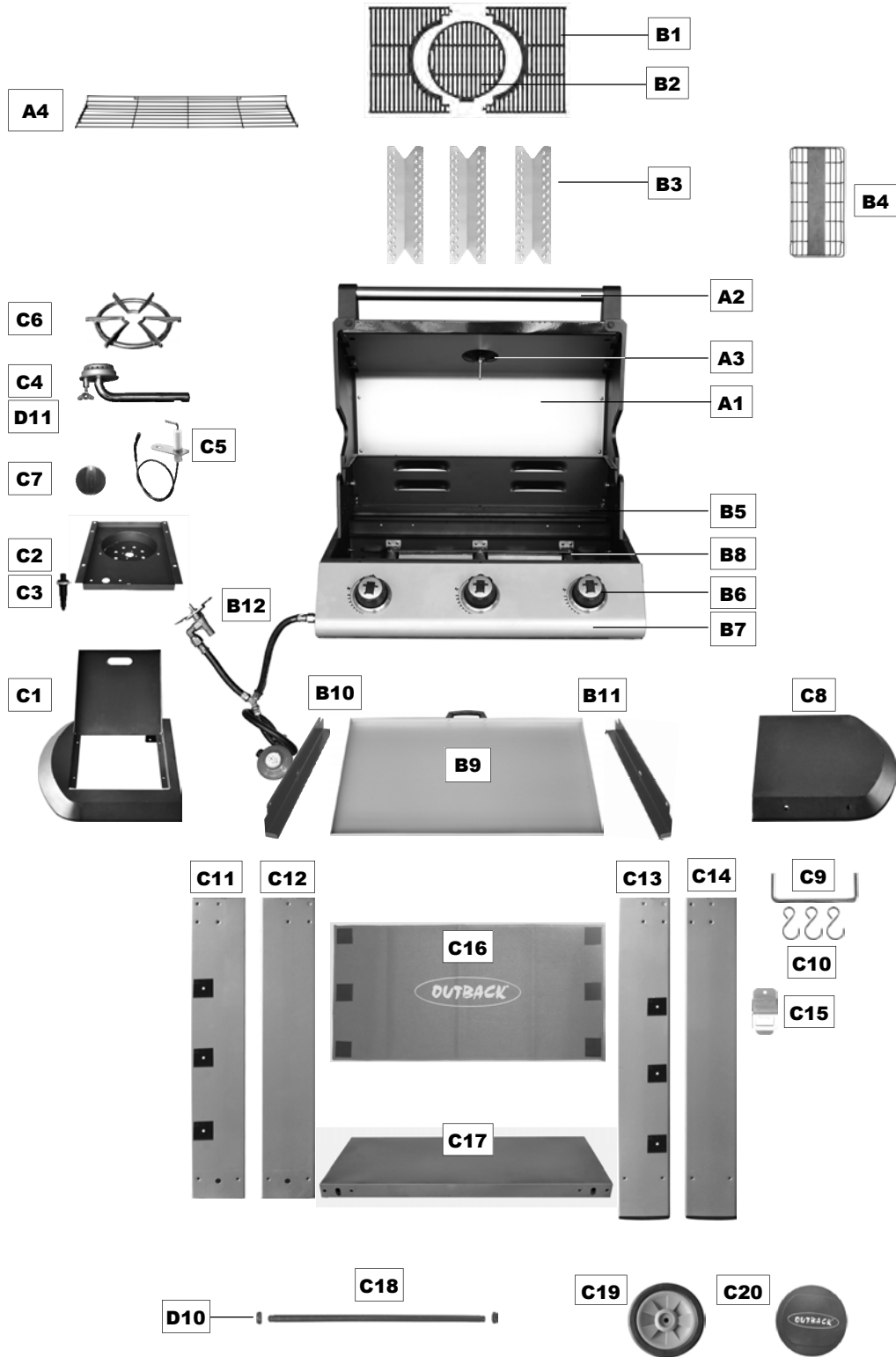

Hardware Reference Diagram

Specifications subject to change without prior notice.

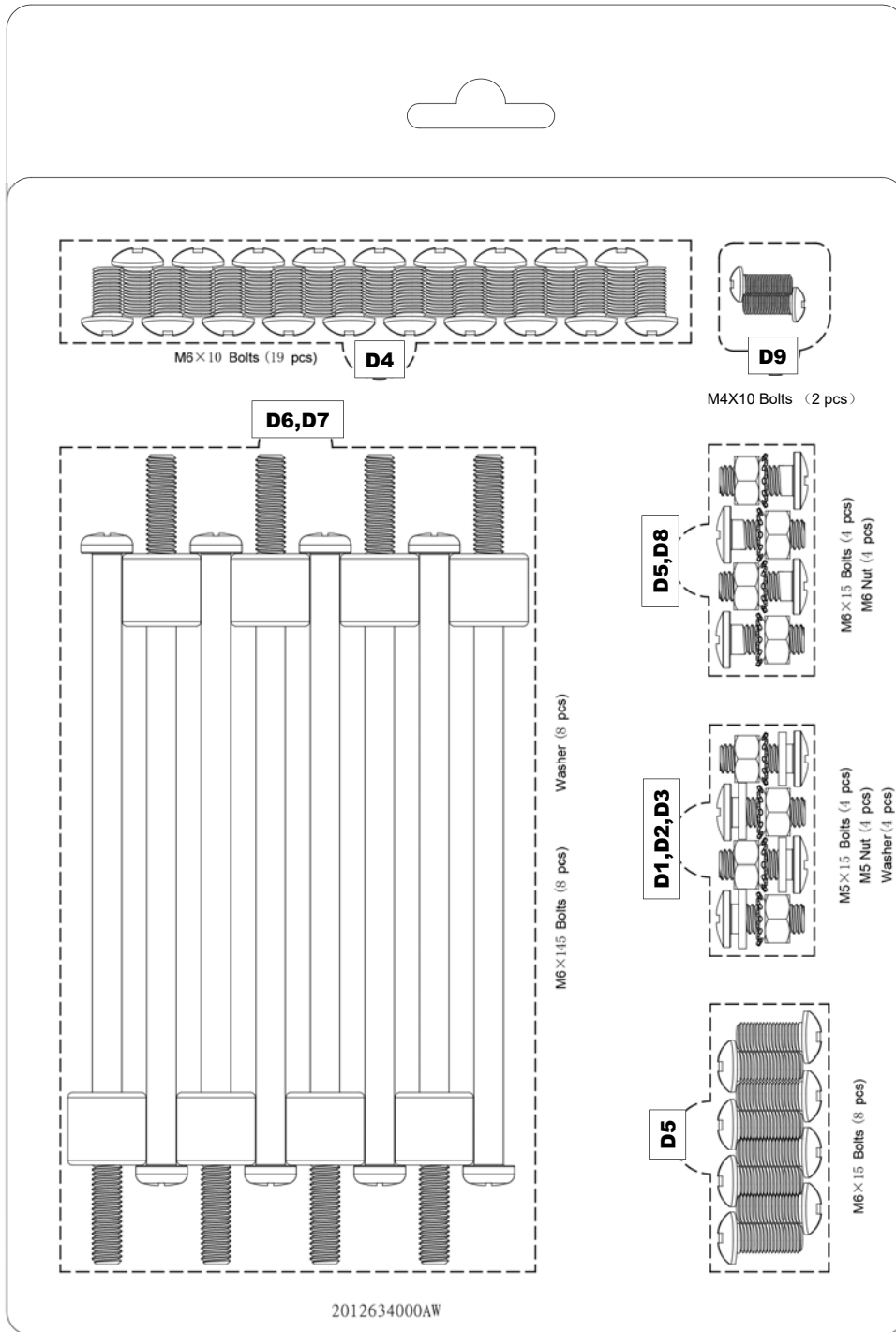

Assembly

IMPORTANT!

- **TOOLS NEEDED FOR ASSEMBLY:** Medium size flat blade or Phillips/Crosspoint screwdriver, adjustable spanner or metric spanner set.
- The assembly of this barbecue at least requires 2 people.
- Remove any internal components or packaging from the barbecue body.
- Whilst every care is taken in the manufacture of this product, care must be taken during assembly in case sharp edges are present.
- **Please read the Important Information section carefully before assembly and use of your barbecue.**

1

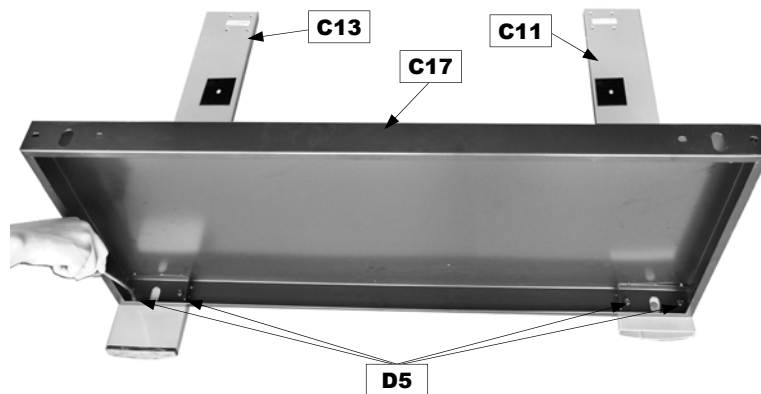

Attach the Left Front Leg (C11) and Right Front Leg (C13) onto the Trolley Base (C17) using the M6x15 Bolts (D5x4pcs) as shown.

2

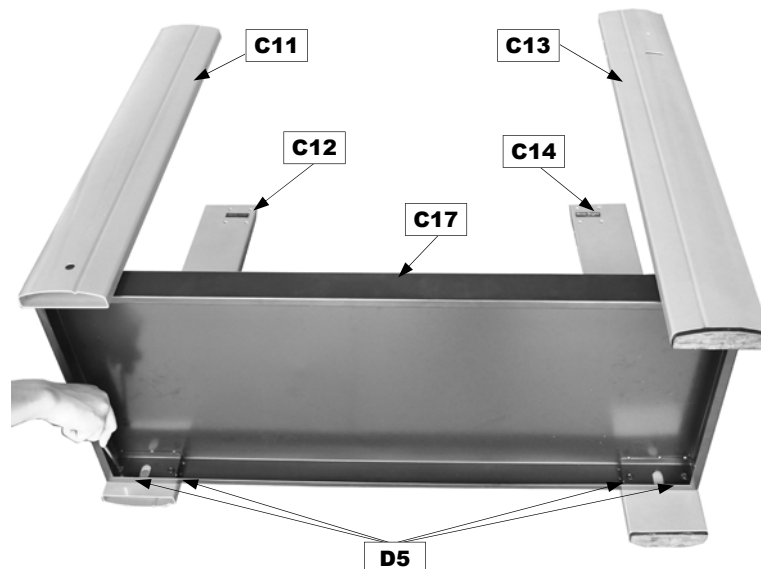

Attach the Left Rear Leg (C12) and Right Rear Leg (C14) to the Trolley Base (C17) using the M6x15 Bolts (D5x4pcs) as shown.

3

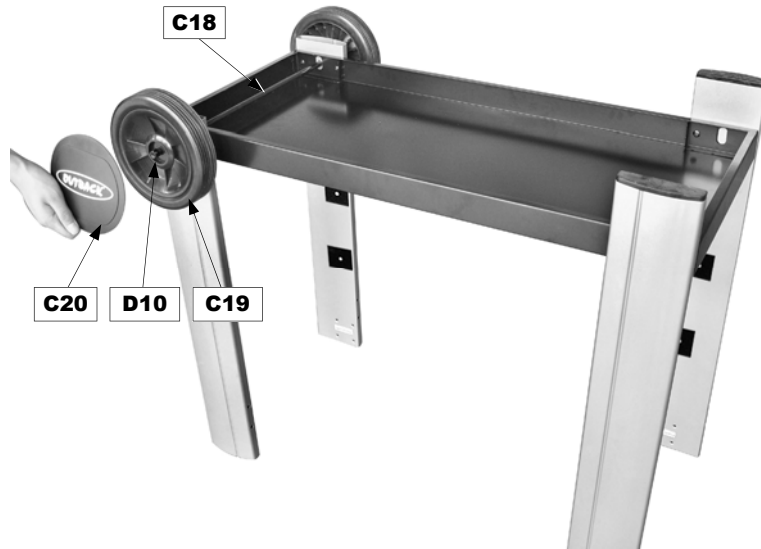

Unscrew the Locknuts (D10x2pcs) from both ends of the Axle (C18). Slide the axle through the corresponding holes in the left legs. Slide the Wheels (C19) over each end of the axle. Secure the wheels into place with the locknuts. Place the Hubcaps (C20) onto the outsides of the wheels.

4

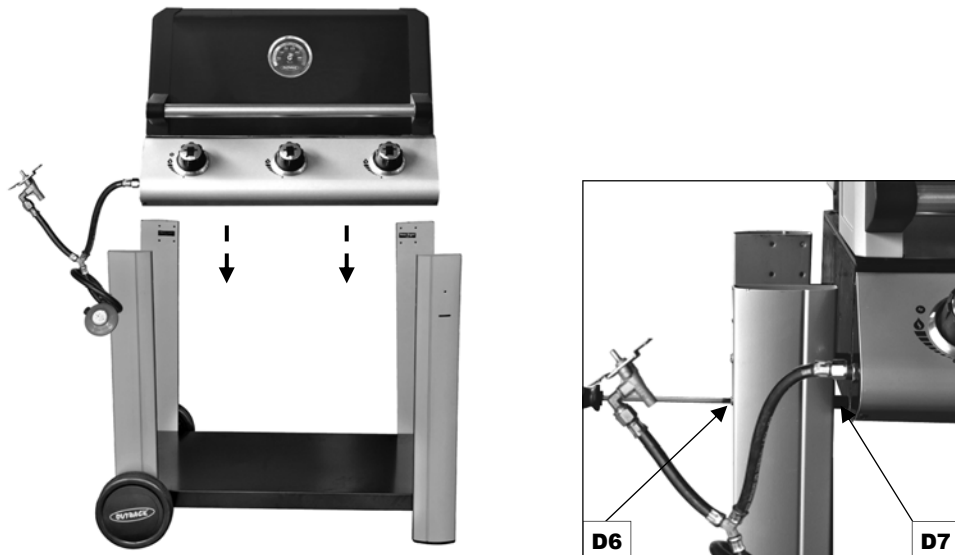

Insert M6x145 Bolts (D6x8pcs) through the trolley legs, the Spacers (D7x8pcs), and keep the tip of the bolts inside the spacers. While holding the barbecue body into position (2 people required), screw the bolts into the barbecue body as shown.

CAUTION! Care must be taken to ensure the hood or lid does not fall open unexpectedly or becomes damaged when it is set on the ground.

5

(Rear view of the barbecue trolley.)

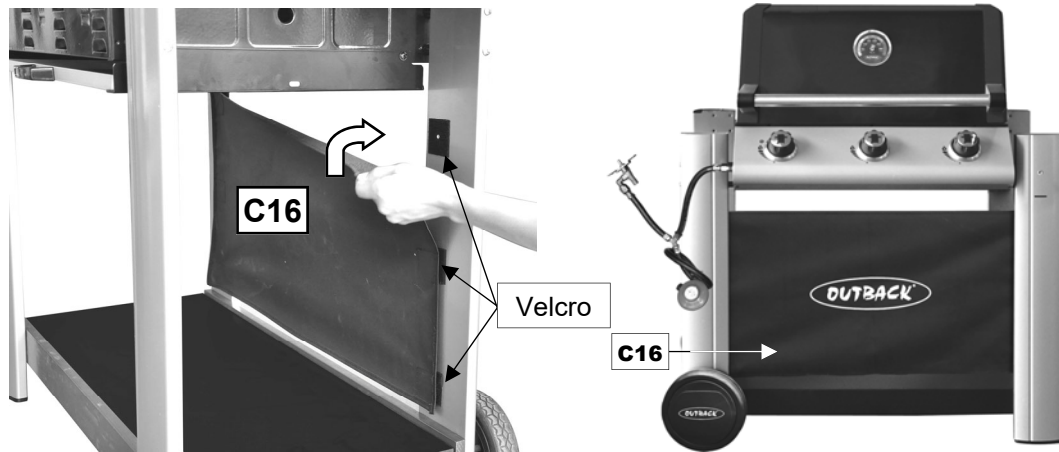

Attach the Front Screen (C16) to the Front Left / Right Legs as shown.

6

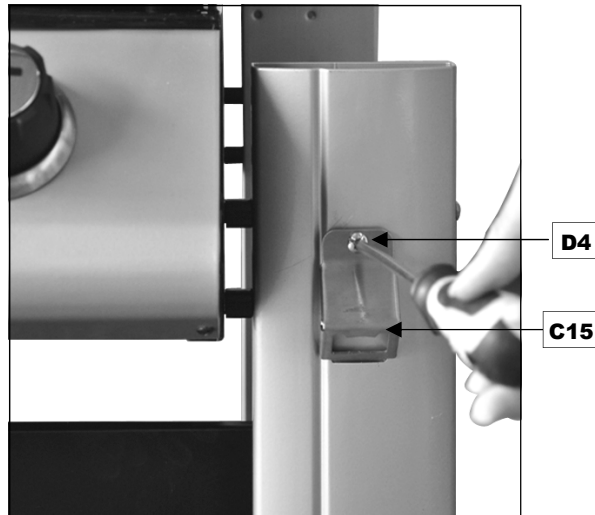

Attach the Bottle Opener (C15) to the right front leg using M6x10 Bolts (D4x1pc).

7

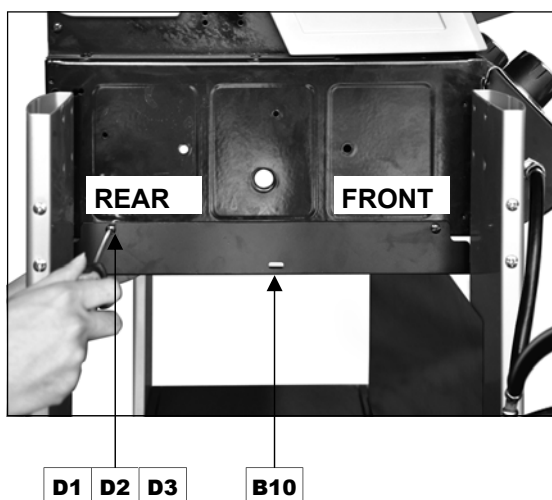
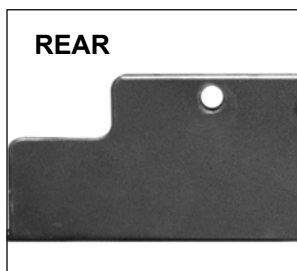
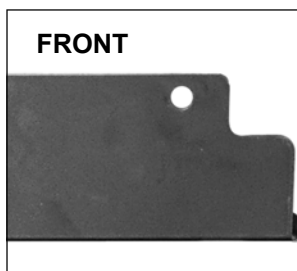

Attach Drip Tray Left Bracket (B10) to barbecue body using M5x15 Bolts (D1x2pcs), M5 Washers (D2x2pcs) and M5 Nuts (D3x2pcs) as shown. Repeat above process for Drip Tray Right Bracket (B11).

NOTE: Ensure that the big tabs of the brackets which stop the drip tray are located at the front of the barbecue.

8



Attach the Side Burner Shelf (C1) to the Left Front / Rear Legs using M6x10 Bolts (D4x8pcs).

9

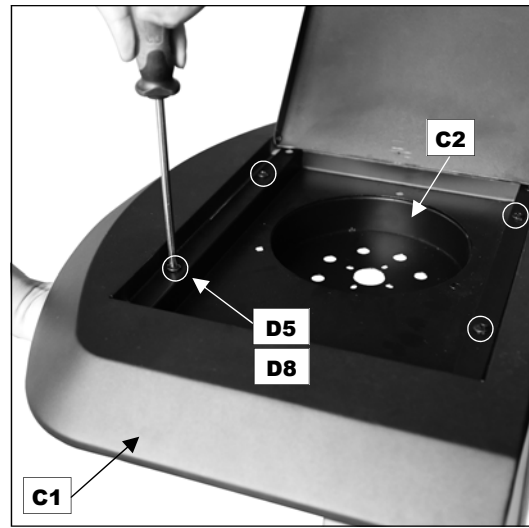
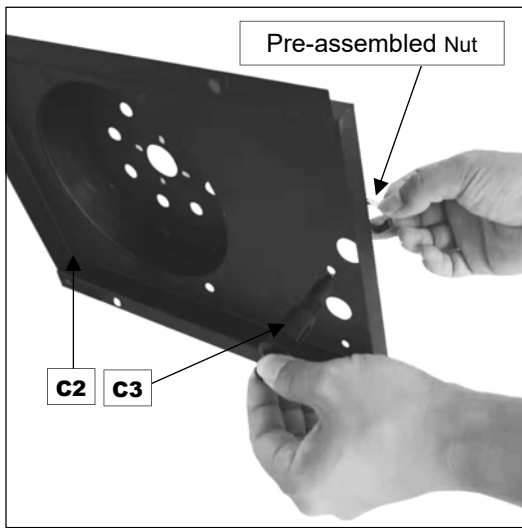

Unscrew the pre-assembled nut of the Ignition Button (C3). Insert the Ignition Button (C3) into the hole at the Side Burner Base(C2) and secure with the pre-assembled nut. Carefully lay the Side Burner Base(C2) into the Side Burner Shelf (C1) and make sure it is horizontal, Then fixing the Side Burner Base using M6x15 Bolts (D5x4pcs) and M6 Nuts (D8x4pcs).

10

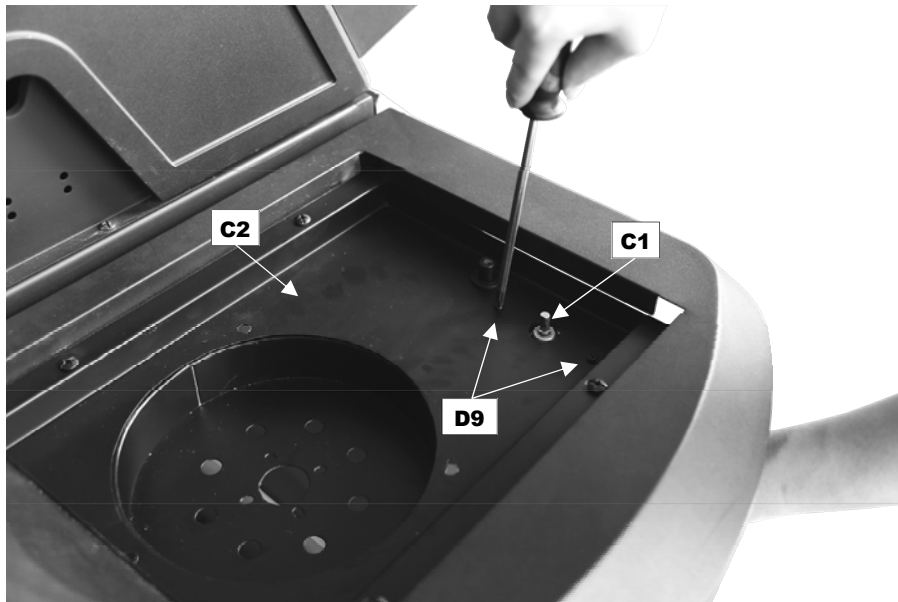

Attach the side burner valve onto the Side Burner Base (C2) using M4x10 Bolts (D9x2pcs) as shown.

11

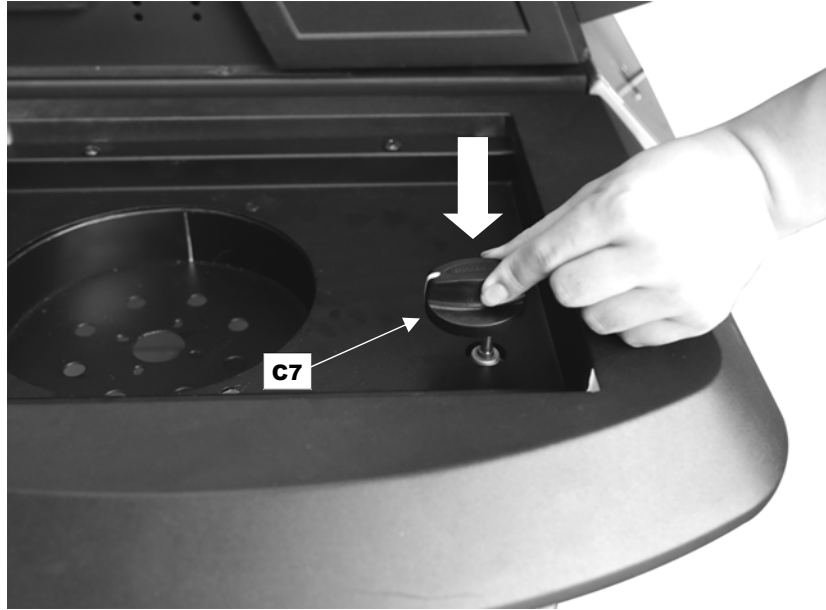

Press the Side Burner Knob (C7) onto side burner valve stem.

12

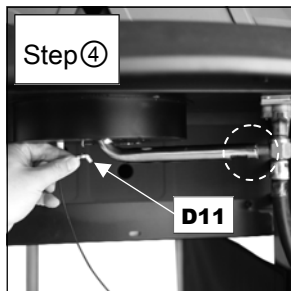
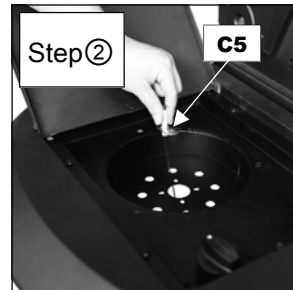
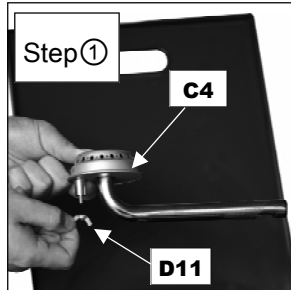

Unscrew the pre-assembled Wing Nut (D11) from the Side Burner (C4). Insert the Wire of Side Burner Electrode (C5) into the hole at the Side Burner Base(C2) . Feed the venturi tube of the side burner through the hole in bottom of side burner base as shown, then fix it and the side burner electrode onto side burner base using the wing nut. **Make sure that the end of venturi tube is set over the gas outlet of side burner valve.**

13

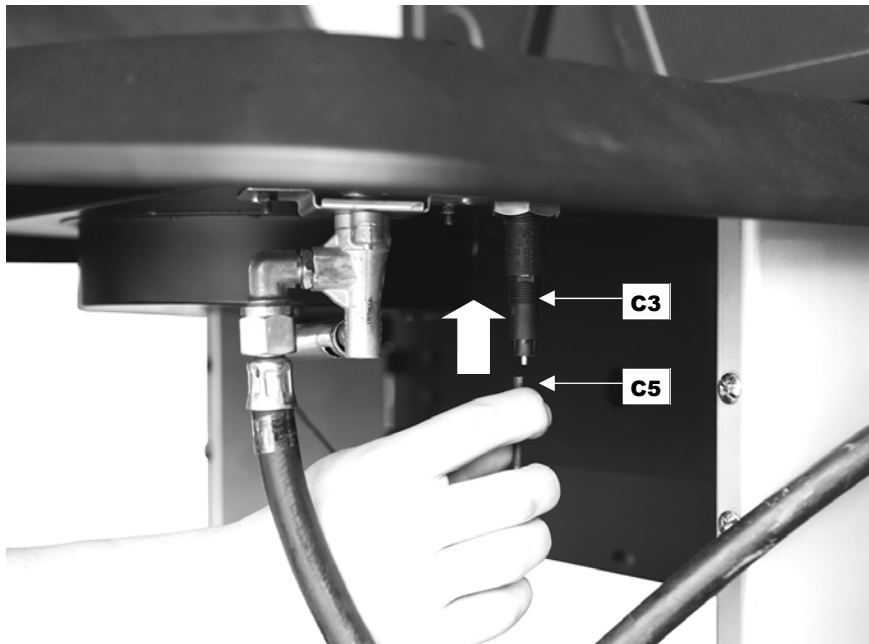

Connect the wire of Side Burner Electrode (C5) to the Side Burner Ignition Pushbutton (C3) as shown.

14

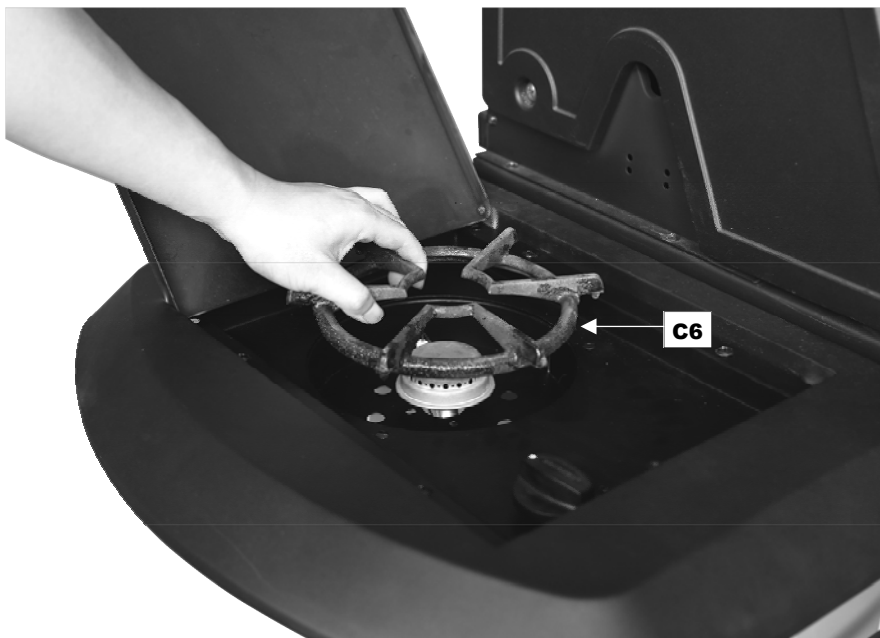

Place Side Burner Grid (C6) onto the Side Burner Base (C2).

NOTE: Only use cookware with a base diameter or between 150mm and 220mm on the side burner.

15

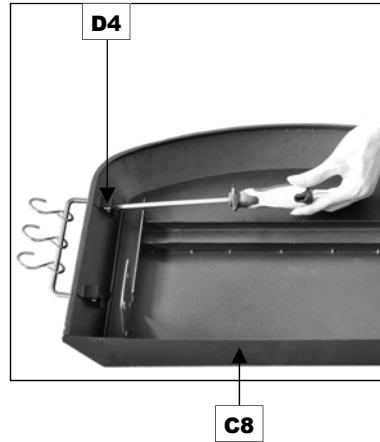
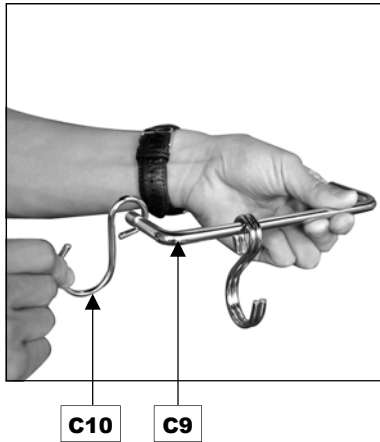

Attach the Tool Hooks (C10) to the Tool Hook Support (C9) as shown, Make sure the direction of tool hook is facing outward. Attach the Tool hook assembly to the Side Shelf (C8) using M6x10 Bolts (D4x2pcs).

16

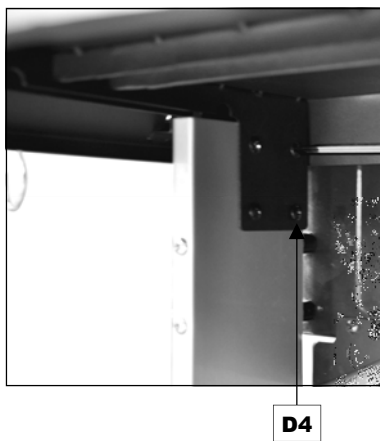

Attach the Side shelf and Tool hook assembly to the Right Front / Rear Legs using M6x10 Bolts (D4x8pcs), as shown.

17



Place the Flame Tamers (B3) over left and middle burners within barbecue body. Lay the Cooking Grill (B1) and Round Grill (B2) into place.

NOTE: Ensure that the flame tamers lies directly underneath the grills.

18



Attach the Warming Rack (A4) to the Barbecue body as shown.

19

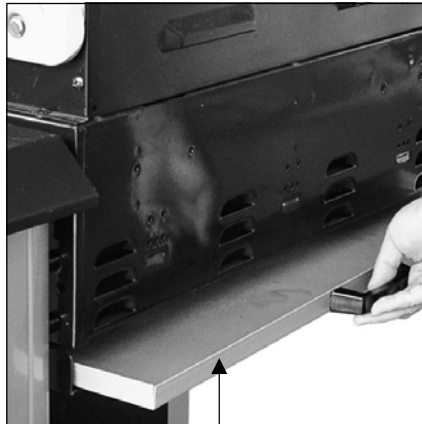

B9

Insert the Drip Tray (B9) by sliding it underneath the barbecue body.



ASSEMBLY IS NOW COMPLETE.

Leak Test Diagram



1. Maximum diameter or breadth is 320mm.
2. Maximum height (regulator included) is 700mm.

PROCEED TO THE NEXT PAGE FOR INSTRUCTIONS ON OPERATION AND MAINTENANCE

ALL JOINTS AND CONNECTIONS MUST NOW BE **LEAK TESTED** BEFORE USING THE BARBECUE.

Leak test annually, and whenever the gas bottle is removed or replaced.

Leak Testing

Always perform a leak test in a well-ventilated area.

Step 1 - Confirm all control knobs are in the off position.

Step 2 - Turn the gas on / open the gas control valve on the gas bottle or regulator.

Step 3 - Check for leaks by brushing a solution of $\frac{1}{2}$ water and $\frac{1}{2}$ liquid detergent / soap over all the gas system joints, including gas bottle valve connections, hose connections, and regulator connections.

Step 4 - NEVER USE AN OPEN FLAME to test for leaks at any time.

Step 5 - If bubbles form over any of the joints there is a leak

- Turn off the gas supply at the gas bottle
- Retighten all joints
- Repeat test
- If bubbles form again do not use the barbecue and contact your local distributor for assistance.

Always wipe the mixed solution ($\frac{1}{2}$ water and $\frac{1}{2}$ liquid detergent / soap) from all joints and connections after leak testing.

Important Information

Please read these instructions carefully before assembly and use of your barbecue.

- ▲ Retain these instructions for future reference.
- ▲ This product is for outdoor use only. Do not use indoors.
- ▲ Do not use the barbecue or store gas bottles below ground level. LP gas is heavier than air so if a leak occurs the gas will collect at a low level and could ignite in the presence of a flame or spark.
- ▲ For use with LPG bottled gas only. A suitable regulator must be used for butane, propane or mixes.
- ▲ Remove plastic wrap from any part before lighting.
- ▲ Do not use within 1m of any flammable structure or surface. Do not use under any combustible surface.
- ▲ LP gas bottles should never be placed directly underneath the barbecue.
- ▲ LP gas bottles should never be stored or used laid on their side, in the horizontal position. A leak would be very serious and liquid could enter the gas line with serious result.
- ▲ Never store gas bottles indoors.
- ▲ Open the barbecue hood before lighting.
- ▲ Once lit, do not move the barbecue until it has completely cooled, after use.
- ▲ This barbecue must not be left unattended when lit.
- ▲ The hood or lid handle can become very hot. Grip only the centre of the handle. Always use oven gloves when cooking or carrying out any adjustments to the barbecue.
- ▲ Use purpose designed barbecue tools with long, heat resistant handles.
- ▲ Use Caution when opening hood or lid, as hot steam inside is released upon opening.
- ▲ Parts of this barbecue become very hot – care must be taken, especially when children, elderly people, and animals are present.
- ▲ Turn off the gas supply at the gas bottle after use.
- ▲ Never cover a barbecue until it has completely cooled.
- ▲ Use this barbecue only on a stable, flat surface.
- ▲ Before you use your barbecue, perform a

leak test. This is the only safe and sure way to detect any gas leaking from joints and connections of the barbecue after assembly.

- ▲ Leak test annually, and whenever the gas bottle is removed or replaced.
- ▲ Do not store flammable materials near this barbecue.
- ▲ Do not use aerosols near this barbecue.
- ▲ Failure to follow the manual's instructions could result in serious injury or damage.
- ▲ Parts sealed by the manufacturer or his agent must not be altered by the user.
- ▲ Modification of the barbecue may be dangerous, is not permitted and will nullify any warranty.
- ▲ If you have any queries regarding these instructions, contact your local dealer.

Gas, Regulator and Hose

This barbecue includes a regulator which is suitable for use with Propane Patio Gas bottles. For optimal performance, we suggest to use a 13kg size gas bottle. Propane bottles will supply gas all year round, even on cold winter days. A spanner may be required to change gas bottles.

- The hose should hang freely with no bends, twisting, tension, folds, or kinks that could obstruct free flow of gas. Always inspect the hose for cuts, cracks, or excessive wear before use.
- Apart from the connection point, no part of the hose should touch any hot barbecue parts. If the hose shows any sign of damage it must be replaced with a hose suitable for use with LP gas which meets the national standards for the country of use.
- A suitable hose must comply with EN16436-1 or local regulation, and the length should not exceed 1.5 metres.

The regulator included with this barbecue complies with EN16129. **YOU MUST HAVE THE PROPER REGULATOR AND GAS BOTTLE IN ORDER FOR THE BARBECUE TO OPERATE SAFELY AND EFFICIENTLY. USE OF AN INCORRECT OR FAULTY REGULATOR OR GAS BOTTLE IS DANGEROUS AND WILL INVALIDATE ANY WARRANTY.** In the case of replacing your original hose and regulator, please consult your local gas dealer for the most suitable regulators and gas bottles.

Installation

Selecting a Location

This barbecue is for **outdoor use only** and should be placed in a well-ventilated area, and on a safe and even surface. Never place your barbecue below ground level. Take care to ensure that it is not placed UNDER any combustible surface. The sides of the barbecue should NEVER be closer than 1 metre from any combustible surface, including trees and fences and make sure that there are no heat sources near the barbecue (cigarettes, open flames, spark etc.). Keep this barbecue away from any flammable materials!

Precautions

Do not obstruct any ventilation openings in the barbecue body.

Position the gas bottle on level ground next to the barbecue and safely away from any source of heat.

Should you need to install or change the gas bottle, confirm that the barbecue is switched off, and that there are no sources of ignition (cigarettes, open flame, sparks, etc.) near before proceeding.

Connecting a Gas Hose to the Barbecue

Connect the gas hose to the gas rail inlet on the barbecue. Do not overtighten. Do not use any sealing tape, paste or liquid on the connection.

Fixing a Regulator to the Gas Bottle

Confirm all barbecue control knobs are in the off position. Connect the regulator to the gas bottle according to your regulator and bottle dealer's instructions.

Operation

▲Warnings

▲ Before proceeding, make certain that you understand the IMPORTANT INFORMATION section of this manual.

▲ Your barbecue is not designed to be used with more than 50% of the cooking area as a solid plate — this includes baking dishes. Full coverage will cause excessive build-up of heat and damage the barbecue. This is not covered by warranty.

Preparation Before Cooking

To prevent foods from sticking to the cooking surface, please use a long handled brush to **apply a light coat of cooking or vegetable oil before each barbecuing session.** (Note: When cooking for the first time, paint colours may change slightly as a result. This is normal and should be expected.)

Line the drip tray with aluminium foil, then place a uniform layer of clean, dry sand 6-8mm deep into the tray. This will absorb excess cooking fat, thus making cleanup easy.

Lighting the Barbecue

- Open the barbecue hood or lid before lighting. Never light your barbecue with the hood or lid closed.
- Ensure all knobs are in the off position. Open the gas control valve on the gas bottle or regulator.
- Push the control knob of the burner you wish to light and turn it anti-clockwise until you feel resistance to the turning. Pause 4 seconds, then continue turning the control knob until a click is heard and the burner is lit. Repeat previous step several times until the burner is lit.
- Ignite any of the remaining burners in any order, as needed. Confirm each burner is alight before igniting another burner.
- If burner fails to ignite after following above procedure, turn all the knobs to the off position. Close the gas valve on the gas bottle. Wait 5 minutes. Reattempt all of the above steps. If the barbecue still fails to light, please refer to the manual ignition instructions below.
- After ignition, turn the burners to the high position for 3-5 minutes in order to pre-heat the barbecue. This should be done before each cooking session. The hood or lid should be open during preheating.
- After completion of preheating, turn all burners to the low position for best cooking results.

Manual lighting instructions

- Open the barbecue and side burner hood or lid before lighting. Never light your barbecue or side burner with the hood or lid closed.
- Ensure all knobs are in the off position. Open the gas control valve on the gas bottle or regulator.
- Insert lit match through the right match-

lighting hole on the right side of the barbecue body and place near rightmost burner porthole.

- Push and turn the rightmost control knob anti-clockwise to the high position, taking care to protect yourself from the flames.
- When the right burner is lit, turn the remaining burners on from right to left.
- Confirm that each burner is alight before turning on the next burner.
- If a burner fails to ignite, contact your local dealer for assistance.
- After ignition, turn the burners to the high position for 3-5 minutes in order to pre-heat the barbecue. This should be done before each cooking session. The hood or lid should be open during preheating.
- After completion of preheating, turn all burners to the low position for best cooking results.

Lighting the Side Burner

Raise the side burner lid. Push and turn the side burner control knob anti-clockwise to the high position. Push the ignition button rapidly until the side burner ignites. If the side burner fails to ignite, turn the control knob to the OFF position and wait five minutes before attempting to re-light following the above procedure. If the side burner still fails to ignite, turn the control knob off, wait five minutes and light with match.

When using the side-burner, care should be taken to ensure that pans are central and flat on the side-burner grid.

Grill Cooking

The burners heat up the flame tamer, underneath the grill, which in turn heats the food on the grill. The natural food juices produced during cooking fall onto the flame tamer below and vaporise. The subsequent rising smoke bastes the food, as it travels upwards, imparting that unique barbecued flavour.

Roasting Hood Cooking

Barbecues equipped with a roasting hood give the option to form an 'oven' for roasting or baking food, such as joints of meat or whole chickens, etc. More even cooking of food will actually be achieved by using the barbecue with the hood down. **However, this should only be done with the burners on low.**

For best results, place the food you wish to

bake or roast on a metal baking tray and set it on one side of the cooking grill.

Turn the burner directly under the food to the OFF position and turn all other burners to a LOW to MEDIUM position.

Close the hood to cook the food 'indirectly'. Avoid lifting the hood unnecessarily as heat is lost every time the hood is opened. If the hood is opened during cooking please allow extra time for the barbecue to regain its temperature and complete the cooking. Use the temperature gauge to monitor the heat of the barbecue.

If the internal heat becomes too high, turn the burners down to the low position. It is not necessary or advisable to have all of the burners on high when the hood is closed.

DO NOT ALLOW YOUR BARBECUE TO OVERHEAT. Be careful of hot steam when opening the hood.

Warming Rack

Warming racks are a convenient way to keep cooked food warm or to warm items such as bread rolls. It is advisable to place food (particularly fatty foods) to the front of the warming rack to avoid the possibility of juices and fat running down the back of your barbecue. Always check that your warming rack is properly fitted before use.

Flare-Up Control *Very Important*

Flare-ups occur when meat is barbecued, and its fat and juices fall upon the hot flame tamer. Smoke of course helps give food its barbecued flavour, but it is best to avoid excessive flare-up to prevent food being burned. To control flare-ups, it is **ABSOLUTELY ESSENTIAL** to trim away excess fat from meat and poultry before grilling, use cooking sauces and marinades sparingly and try to avoid very cheap cuts of meat or meat products as these tend to have a high fat and water content. Also, the burners should always be placed on the low setting during cooking.

When flare-ups do occur, they can usually be extinguished by applying baking soda or salt directly onto the flame tamer. Always protect your hands when handling anything near the cooking surface of the barbecue and take care to protect yourself from the flames.

If a fat fire occurs, please see the instructions

given below.

Fat Fires

Empty and clean the drip tray of food debris after each cooking session. If the barbecue is to be used for large gatherings, it will be necessary to turn off and cool the barbecue every two hours to remove food debris from the drip tray and clean it out. The time between cleaning may need to be reduced if very fatty foods or cheap meat products are being cooked. Failure to do this may result in a fat fire, which may cause injury and could seriously damage the barbecue.

In the event of a fat fire:

- If safe to do so, turn all control knobs to the 'off' position.
- Turn off the gas supply at the gas bottle.
- Keep everyone at a safe distance from the barbecue and wait until the fire has burnt out.
- Do not close the hood or lid of the barbecue.
- NEVER DOUSE A BARBECUE WITH WATER. IF AN EXTINGUISHER IS USED, IT SHOULD BE A POWDER TYPE.
- DO NOT REMOVE THE DRIP TRAY
- If the fire does not seem to be abating or appears to be worsening, contact your local Fire Brigade for assistance.

End of Cooking Session

After each cooking session, turn the barbecue burners to the "high" position and burn for 5 minutes. This procedure will burn off cooking residue, thus making cleaning easier. Make sure the hood or lid is open during this process.

Turning Off Your Barbecue

When you have finished using your barbecue, turn all the control valves fully clockwise to the "Off" position, then switch off the gas supply at the bottle.

Wait until the barbecue is sufficiently cool before closing its hood.

Care and Maintenance

Regularly clean your barbecue between uses and especially after extended periods of storage. Ensure the barbecue and its components are sufficiently cool before cleaning. Do not leave the barbecue exposed to outside weather conditions or stored in damp, moist areas.

▲ Never handle hot parts with unprotected hands.

▲ Never douse the barbecue with water when its surfaces are hot.

In order to extend the life and maintain the condition of your barbecue, we strongly recommend that the unit be covered when left outside for any length of time, especially during the winter months. Heavy-duty barbecue covers and other accessories are available from your local stockist.

Even when your barbecue is covered for its protection, it must be inspected on a regular basis as damp or condensation can form which may result in damage to the barbecue. It may be necessary to dry the barbecue and the inside of the cover. It is possible for mould to grow on any fat remaining on parts of the barbecue. This should be cleaned off smooth surfaces with hot soapy water.

Any rust that is found that does not come into contact with the food should be treated with a rust inhibitor and painted with barbecue paint or a heat resistant paint.

Cooking Surfaces & Warming Rack

When the barbecue has cooled, clean with hot soapy water. To remove any food residue, use a mild cream cleaner on a non-abrasive pad. Do not use scouring pads or powders as they can permanently damage the finish. Rinse well and dry thoroughly. Due to the weight of the cooking surfaces, we do not recommend cleaning in a dishwasher.

Should rust appear on the cooking surface in contact with food, it must be changed.

Burner

Provided that they are operating correctly, in normal usage, burning off the residue after cooking will keep the burners clean.

The burners should be removed and cleaned annually, or whenever heavy build-up is found, to ensure that there are no signs of blockage (debris, insects) in either the burner portholes or the primary air inlet of the burners. Use a pipe cleaner to clear obstructions.

When refitting the burners, be careful to check that the neck of the burner fits over the valve outlet.

It is quite normal for surface rust to be present

on the burners. If rust appears between uses or in storage, clean with a soft brass wire brush.

Flame Tamer

Remove any food residue from the flame tamer surface with a plastic or wooden scraper or brass wire brush. Do not use a steel scraper or wire brush. Clean with hot soapy water and rinse well.

Drip Tray

After every use, empty and clean the drip tray (and foil liner, if applicable) of any fat or food particles, using a plastic or wooden scraper if necessary.

Failure to keep it clean, and excessive build up can result in a fat fire. This can be hazardous and severely damage the barbecue. **This is not a fault in the barbecue and is therefore not covered by the terms of the warranty.** If required, the tray can be washed in hot soapy water.

Barbecue Body

Regularly remove excess grease or fat from the barbecue body using a cloth wrung out in hot soapy water and dry thoroughly. Excess fat and food debris can be removed from inside the body using a soft plastic or wooden scraper. It is not necessary to remove all the grease from the body. If you need to clean fully, use hot soapy water and a cloth, or nylon-bristled brush only. Do not use abrasives. Remove cooking surfaces and burners before full cleaning. Do not immerse the gas controls or manifold in water. Check burner operation after carefully refitting into body.

Barbecue Hood or Lid

Use a non-abrasive cloth or pad and clean with hot, soapy water. Do not use scouring pads or powders as they can permanently damage the finish.

Trolley

Wipe with a cloth wrung out in hot soapy water and dry.

Stainless Steel

Stainless Steel is a type of steel containing chromium, which offers high resistance to corrosion and heat by forming a protective layer of Chromium Oxide. Exposure to fat, dirt and water can prevent the protective layer being formed, which can lead to spotting such as surface discolouration and rust.

Stainless steel surfaces can be cleaned using a stainless steel cleaner or methylated spirits and any spotting should be taken care of immediately. Failure to remove spotting can lead to permanent discolouration.

- ▲ Never use a chlorine based cleaner on stainless steel.
- ▲ Do not use a wire brush, steel wool or abrasives as these will strip the protective layer, which can lead to rusting.
- ▲ Always rinse and allow to dry after cleaning.

Fixings

All screws and bolts, etc. should be checked and tightened on a regular basis.

Storage

Ensure the barbecue is properly cooled before covering or storing. Store your barbecue in a cool dry place.

Cover the burners with aluminium foil in order to prevent insects or other debris from collecting in burner holes.

If the barbecue is to be stored indoors, the gas bottle must be disconnected and left outside. The gas bottle should always be stored outside, in a dry, well-ventilated area, away from any sources of heat or ignition. Do not let children tamper with the bottle.

When using the barbecue after extended periods of storage follow the cleaning procedures.

Technical Specifications

Notes:

	CE Approval	Heat Input	Burners	Injector Size	Gas Consumption
Magnum 3 Gas BBQ	0359 359BR665	12.96 kW	3	1.02mm	Butane: 943g/hr Propane: 926g/hr
Side Burner	0359 359BR665	2.44 kW	1	0.76mm	Butane: 178g/hr Propane: 174g/hr

Category: I₃₊ (28-30/37)

Gas / Pressure: G30 Butane at 28-30mbar and G31 Propane at 37mbar

Countries of Use: BE, CH, CY, CZ, ES, FR, GB, GR, IE, IT, LT, LU, LV, PT, SK, SI

Category: I_{3B/P(30)}

Gas / Pressure: G30 Butane and G31 Propane at 30mbar

Countries of Use: AL, BG, CY, CZ, DK, EE, FI, FR, HR, HU, IS, IT, LT, LU, MK, MT, NL, NO, RO, SE, SI, SK, TR

Specifications are subject to change without prior notice.

Troubleshooting

Problem	Possible Cause	Solution
Burner will not light using the ignition system	LP gas bottle is empty	Replace with full bottle
	Faulty regulator	Have regulator checked or replaced
	Obstructions in burner	Clean burner
	Obstructions in gas jets or gas hose	Clean jets and gas hose
	Electrode wire is loose is connected on electrode	Reconnect wire
	Electrode or wire is damaged	Change electrode and wire
	Faulty integral ignitor	Change ignitor
Burner will not light with a match	LP gas bottle is empty	Replace with full bottle
	Faulty regulator	Have regulator checked or replaced
	Obstructions in burner	Clean burner
	Obstructions in gas jets or gas hose	Clean jets and gas hose
Low flame or flashback (fire in burner tube— a hissing or roaring noise may be heard)	LP gas bottle too small	Use larger bottle
	Obstructions in burner	Clean burner
	Obstructions in gas jets or gas hose	Clean jets and gas hose
	Windy conditions	Use barbecue in a more sheltered position
Gas valve knob difficult to turn	Integral ignition system jammed	Replace gas valve
	Gas valve jammed	Replace gas valve

Manufacturer:
 TPA Industrial (DG) Co. Ltd.
 Xingguang Rd., Huangjiang, Dongguan
 Guangdong, China 523768

OUTBACK® WARRANTY

OUTBACK® barbecues are warranted to the original purchaser against defects in materials and workmanship:

- ◆ Porcelain coated roasting hoods and stainless steel roasting hoods are warranted for a period of two (2) years from the date of purchase.
- ◆ Stainless steel burners and cast iron burners are warranted for a period of two (2) years from the date of purchase.
- ◆ Other parts are warranted for a period of one (1) year from the date of purchase.

OUTBACK® will, within above periods, supply replacements for defective parts free of charge provided that:

- ◆ The product has not been used for trade, professional or hire purposes.
- ◆ The product has not been subjected to misuse or neglect, including fat fires and flare ups or use of a faulty or incorrect regulator.
- ◆ The product has not sustained damage through foreign objects, substances or accidents.
- ◆ The care and maintenance instructions given in your Outback manual have been followed.

If the product includes one or a number of parts or accessories, only the defective accessory or part will be replaced i.e. Hose, Regulator, Rotisserie, Piezo Ignitor, Roast Hood and Side Burner.

Fat fires are not covered under warranty.

Any warranty & guarantee claims shall be rendered void in the event of improper use of the BBQ or the use of non approved fuels, discolouration , rusting or slight deformation of parts exposed directly to the flames (grill / griddle / flame tamers / burners ,etc) do not impair the function of the BBQ and do not form a basis for any claims.

This warranty is offered as an extra benefit and is in addition to the customers' statutory rights.

OUTBACK® does not in any way warranty the gas cylinder.

In the unlikely event that you experience problems with this barbecue, please fill in our warranty form at:

<http://www.outbackbarbecues.com/warranty-form>

One of our colleagues will be in contact with you shortly.

For reference and correspondence, record your serial number here.
(See sticker on side of barbecue body.)

Serial No. _____

This number may be required when ordering spare parts or accessories. A part reference number may also be required where applicable.

HELPLINE NUMBER: 0143 226 6474